



AVTECH ELECTROSYSTEMS LTD.

NANOSECOND WAVEFORM ELECTRONICS  
SINCE 1975

P.O. BOX 265  
OGDENSBURG, NY  
U.S.A. 13669-0265

TEL: 888-670-8729 (USA & Canada) or +1-613-686-6675 (Intl)  
FAX: 800-561-1970 (USA & Canada) or +1-613-686-6679 (Intl)

info@avtechpulse.com - <http://www.avtechpulse.com/>

BOX 5120, LCD MERIVALE  
OTTAWA, ONTARIO  
CANADA K2C 3H4

## INSTRUCTIONS

MODEL AVR-EB4-B

+2A / -4A REVERSE RECOVERY

MEASUREMENT SYSTEM

WITH 4.5 ns SWITCHING TIME

SERIAL NUMBER: \_\_\_\_\_

### WARRANTY

Avtech Electrosystems Ltd. warrants products of its manufacture to be free from defects in material and workmanship under conditions of normal use. If, within one year after delivery to the original owner, and after prepaid return by the original owner, this Avtech product is found to be defective, Avtech shall at its option repair or replace said defective item. This warranty does not apply to units which have been disassembled, modified or subjected to conditions exceeding the applicable specifications or ratings. This warranty is the extent of the obligation assumed by Avtech with respect to this product and no other warranty or guarantee is either expressed or implied.

### TECHNICAL SUPPORT

Phone: 888-670-8729 (USA & Canada) or +1-613-686-6675 (International)

Fax: 800-561-1970 (USA & Canada) or +1-613-686-6679 (International)

E-mail: [info@avtechpulse.com](mailto:info@avtechpulse.com)

World Wide Web: <http://www.avtechpulse.com>

TABLE OF CONTENTS

**WARRANTY.....2**

**TECHNICAL SUPPORT.....2**

**TABLE OF CONTENTS.....3**

**INTRODUCTION.....6**

**SPECIFICATIONS.....8**

**EUROPEAN REGULATORY NOTES.....9**

**EC DECLARATION OF CONFORMITY.....9**

**DIRECTIVE 2002/95/EC (RoHS).....9**

**DIRECTIVE 2002/96/EC (WEEE).....9**

**INSTALLATION.....11**

**VISUAL CHECK.....11**

**POWER RATINGS.....11**

**CONNECTION TO THE POWER SUPPLY.....11**

**PROTECTION FROM ELECTRIC SHOCK.....12**

**ENVIRONMENTAL CONDITIONS.....12**

**FUSES.....14**

**AC FUSE REPLACEMENT.....14**

**DC FUSE REPLACEMENT.....15**

**FUSE RATINGS.....15**

**FRONT PANEL CONTROLS.....16**

**REAR PANEL CONTROLS.....18**

**TIMING CONTROL.....20**

**BASIC TIMING CONTROL.....20**

**TRIGGER MODES.....22**

**GATING MODES.....22**

**BASIC AMPLITUDE CONTROL.....23**

**SETTING THE AMPLITUDE LEVELS.....24**

**AMPLITUDE ACCURACY.....25**

**INCORRECT ORIENTATION.....25**

**CABLE LENGTHS.....25**

**ACCESSIBLE VOLTAGES.....26**

**STANDARD TEST JIG MECHANICAL ASPECTS.....27**

AVX-TRR-MIX TEST JIG.....	27
<b>TYPICAL RESULTS.....</b>	<b>30</b>
1N4937 RESULTS.....	30
J5418 RESULTS.....	32
1N4004 RESULTS.....	33
MUR8100E RESULTS.....	34
RUS460 RESULTS.....	36
CSD10120 RESULTS.....	38
UTG8042 RESULTS.....	39
<b>SPECIALIZED TEST JIGS.....</b>	<b>41</b>
AXIAL NO-BEND JIGS.....	41
MELF PACKAGES.....	42
CHIP-LEVEL TESTS.....	43
DO-4 AND DO-5 STUD PACKAGES.....	44
AVX-TRR-BTA TEST JIG.....	46
<b>TROUBLESHOOTING.....</b>	<b>49</b>
<b>PROGRAMMING YOUR PULSE GENERATOR.....</b>	<b>50</b>
KEY PROGRAMMING COMMANDS.....	50
ALL PROGRAMMING COMMANDS.....	51
<b>MECHANICAL INFORMATION.....</b>	<b>53</b>
TOP COVER REMOVAL.....	53
RACK MOUNTING.....	53
ELECTROMAGNETIC INTERFERENCE.....	53
<b>MAINTENANCE.....</b>	<b>54</b>
REGULAR MAINTENANCE.....	54
CLEANING.....	54
<b>WIRING DIAGRAMS.....</b>	<b>55</b>
WIRING OF AC POWER.....	55
PCB 158N - LOW VOLTAGE POWER SUPPLY, 1/3.....	56
PCB 158N - LOW VOLTAGE POWER SUPPLY, 2/3.....	57
PCB 158N - LOW VOLTAGE POWER SUPPLY, 3/3.....	58
PCB 168B - HIGH VOLTAGE DC POWER SUPPLY.....	59
PCB 104D - KEYPAD / DISPLAY BOARD, 1/3.....	60
PCB 104D - KEYPAD / DISPLAY BOARD, 2/3.....	61

<b>PCB 104D - KEYPAD / DISPLAY BOARD, 3/3.....</b>	<b>62</b>
<b>MAIN WIRING.....</b>	<b>63</b>
<b>STANDARD TEST JIG WIRING (AVX-TRR-MIX).....</b>	<b>64</b>
<b>TEST JIG WIRING (AVX-TRR-AXPOST).....</b>	<b>65</b>
<b>TEST JIG WIRING (AVX-TRR-SCHA / AVX-TRR-MSB-MELF).....</b>	<b>66</b>
<b>TEST JIG WIRING (AVX-TRR-SCHA / AVX-TRR-MSB-STUD).....</b>	<b>67</b>
<b>TEST JIG WIRING (AVX-TRR-BTA).....</b>	<b>68</b>
<b><i>PERFORMANCE CHECK SHEET</i>.....</b>	<b>69</b>

Manual Reference: /filesserver/officefiles/instructword/avr-eb/avr-eb4/AVR-EB4-B,ed7.odt.  
Last modified May 25, 2009.  
Copyright © 2009 Avtech Electrosystems Ltd, All Rights Reserved.

## INTRODUCTION

The AVR-EB4-B is a high performance, GPIB and RS232-equipped instrument capable of generating a +100V / -200V bipolar waveform into a 50 Ohm resistance. Normally, a diode will be placed in series with this resistance, allowing diode currents of up to +2A and -4A to be generated.

More specifically, the AVR-EB4-B mainframe generates a 2-20 us wide forward-bias pulse with amplitude adjustable up to +100V/+2A, which is immediately followed by a 2-20 us wide reverse-bias pulse with amplitude up to -200V/-4A. The forward and reverse amplitudes and pulse widths are independently variable. The forward-to-reverse switching time is < 4.5 ns (10%-90%).

The current waveforms generated by this instrument are suitable for MIL-STD-750E Method 4031.4 Test Condition B tests. (Avtech can also provide separate test systems for Condition D tests). In the terminology of this standard,  $V_3 = 0$  to +200V,  $V_4 = 0$  to -200V,  $R_F = 50$  Ohms,  $R_4 = 50$  Ohms, and  $R_R \approx 0$ . These values differ from the values suggested in the standard, but the use of 50 Ohm resistances allows common coaxial cabling to be used for flexible connection arrangement, and greatly reduces the  $\tau = L / R$  time constants that plague measurement systems based on the suggested values. As a result, the measurements are more accurate and more repeatable. (For additional information about the rationale behind the basic approach, please see Avtech Technical Brief 15, "A Comparison of Reverse Recovery Measurement Systems", at <http://www.avtechpulse.com/appnote>.)

The values of  $I_F$ ,  $I_{RM}$ , and  $i_{R(REC)}$  produced by this instrument are suitable for MIL-STD-750E Method 4031.4 Test Conditions B1-B4. (Condition B4 is not recommended by Avtech, however, because the high  $I_{RM} / i_{R(REC)}$  ratio will make the results more sensitive to parasitic effects.)

Standard AVR-EB4-B models include one AVX-TRR-MIX diode test jig. The instrument mainframe is connected to the test jig using one coaxial cable and one DB-9 control cable. The standard test jig contains a variety of pin sockets and posts, which may be used to hold the diode device under test (DUT). The test jig has a hinged lid, which must be fully closed to protect the user from high voltages. The output will be automatically disabled if the lid is left open. The standard AVR-TRRA test jig will accommodate TO-220AC (2 lead) packages, DO-style packages with (leads bent at 90°), and standard and reverse-polarity TO-3 packages.

The AVR-EB4-B may also be provided with different or additional a customized test jigs, to meet particular customer package requirements.

The diode-under-test is connected in series with a 50 Ohm resistance present on the test jig. In order to achieve the full +2A / -4A amplitude, the diode resistance ( $dV/dI$  at high currents) must be much less than 50 Ohms (i.e., 5 Ohms or lower).

One end of the 50 Ohm resistance is connected to ground, and access to the other end is provided through a coaxial connector. This output should be terminated with 50 Ohms, and connected to a high-bandwidth (> 400 MHz) oscilloscope. The voltage across this resistance is directly proportional to the current through the diode. By observing the current waveform through the diode, the reverse recovery time may be determined.

While the provided test jig is intended to be flexible and easy to use, users can also develop their own test jigs easily.

The AVR-EB4-B includes an internal trigger source, but it can also be triggered or gated by an external source. A front-panel pushbutton can also be used to trigger the instrument.

The AVR-EB4-B features front panel keyboard and adjust knob control of the output pulse parameters along with a four line by 40-character backlit LCD display of the output amplitude, pulse repetition frequency, and delay. The instrument includes memory to store up to four complete instrument setups. The operator may use the front panel or the computer interface to store a complete “snapshot” of all key instrument settings, and recall this setup at a later time.

This instrument is intended for use in research, development, test and calibration laboratories by qualified personnel.

## SPECIFICATIONS

Model <sup>1</sup> :	AVR-EB4-B	
Recovery type:	Reverse recovery	
Intended application:	High-speed rectifiers	
Basic waveform:	A positive pulse followed immediately by a negative pulse	
Pulse polarity:	-	+
Voltage output <sup>2,5,6</sup> : (to $R_L = 50\Omega$ )	-2V to -200V	+5V to +100V
Corresponding diode current <sup>2,5</sup> (approx., depends on $V_{DIODE}$ ):	-40 mA to -4A	+100 mA to +2A
Pulse width (FWHM):	2 $\mu$ s - 20 $\mu$ s	
Maximum duty cycle:	N/A	
Rise time (10%-90%):	< 4.5 ns	< 1 $\mu$ s
Output impedance during pulse (inside the mainframe):	$\leq 2$ Ohm	50 Ohms
Maximum PRF:	100 Hz	
Delay:	auto-aligned with positive falling edge	0 to $\pm 1.0$ s, variable
Coaxial cable to test jig (supplied):	Normally 60 cm / 2 feet, RG-316 or RG-58C/U. A 5 meter cable is also supplied, in the case shorter cable arrangement generates transmission line reflections.	
Supplied test jig <sup>4</sup> :	Model AVX-TRR-MIX. Includes pin sockets for TO-220AC (2 lead) packages, DO-style packages <sup>3</sup> with leads bent at 90°, and standard and reverse-polarity TO-3 packages. Lead bending is required for axial packages.	
Alternate test jig for axial devices:	Add the suffix -ANB to the model number to replace the standard test jig with one that will accept DO-41 packages (0.205" x 0.107" body, max) and Microsemi Axial Type E packages (0.185" x 0.135" body, max). Unlike the standard jig, bending is NOT required to insert these packages. This jig will not accept any other type of package. This is also available separately as part number AVX-TRR-ANB.	
Other test jigs:	Test jigs are available for MELF packages (AVX-TRR-MELF), DO-4 and DO-5 stud packages (AVX-TRR-STUD), SOT-23 3-pin packages (AVX-TRR-SOT23) and other packages. Contact Avtech for pricing and model numbers. These can be used in place of the standard supplied test jig, and can be ordered at a later time.	
Mainframe connectors:	BNC	
GPIB and RS-232 control:	Standard on -B units. See <a href="http://www.avtechpulse.com/gpib">http://www.avtechpulse.com/gpib</a> for details.	
Trigger required:	Ext trig mode: + 5 Volts, 10 ns or wider (TTL)	
Gate input	Active high or low, switchable. Suppresses triggering when active.	
Power requirements:	100 - 240 Volts, 50 - 60 Hz	
Dimensions:	H x W x D: 100 mm x 430 mm x 375 mm (3.9" x 17" x 14.8")	
Chassis material:	cast aluminum frame and handles, blue vinyl on aluminum cover plates	
Temperature range:	+5°C to +40°C	

- 1) -B suffix indicates IEEE-488.2 GPIB and RS-232 control of amplitude, pulse width, PRF and delay (see <http://www.avtechpulse.com/gpib>).
- 2) For operation at amplitudes of less than 10% of full-scale, best results will be obtained by setting the amplitude near full-scale and using external attenuators on the output.
- 3) DO-15, DO-35, DO-41, DO-201AD, etc.
- 4) Customized jigs available upon request.
- 5) The amplitude settings should not be relied upon for any degree of accuracy, because the dynamics of the device under test can affect the actual generated waveforms. Amplitude settings should always be verified by oscilloscope measurements.
- 6) The diode must have a breakdown voltage exceeding these amplitude limits. Contact Avtech for special arrangements if  $I_{MAX} \times 50\Omega > V_{BR}$ .



## EUROPEAN REGULATORY NOTES

### EC DECLARATION OF CONFORMITY

We Avtech Electrosystems Ltd.  
P.O. Box 5120, LCD Merivale  
Ottawa, Ontario  
Canada K2C 3H4

declare that this pulse generator meets the intent of Directive 89/336/EEC for Electromagnetic Compatibility. Compliance pertains to the following specifications as listed in the official Journal of the European Communities:

EN 50081-1 Emission

EN 50082-1 Immunity

and that this pulse generator meets the intent of the Low Voltage Directive 72/23/EEC as amended by 93/68/EEC. Compliance pertains to the following specifications as listed in the official Journal of the European Communities:

EN 61010-1:2001 Safety requirements for electrical equipment for measurement, control, and laboratory use



### DIRECTIVE 2002/95/EC (RoHS)

This instrument is exempt from Directive 2002/95/EC of the European Parliament and of the Council of 27 January 2003 on the Restriction of the use of certain Hazardous Substances (RoHS) in electrical and electronic equipment. Specifically, Avtech instruments are considered "Monitoring and control instruments" (Category 9) as defined in Annex 1A of Directive 2002/96/EC. The Directive 2002/95/EC only applies to Directive 2002/96/EC categories 1-7 and 10, as stated in the "Article 2 - Scope" section of Directive 2002/95/EC.

### DIRECTIVE 2002/96/EC (WEEE)

European customers who have purchased this equipment directly from Avtech will have completed a "WEEE Responsibility Agreement" form, accepting responsibility for WEEE

compliance (as mandated in Directive 2002/96/EC of the European Union and local laws) on behalf of the customer, as provided for under Article 9 of Directive 2002/96/EC.

Customers who have purchased Avtech equipment through local representatives should consult with the representative to determine who has responsibility for WEEE compliance. Normally, such responsibilities will lie with the representative, unless other arrangements (under Article 9) have been made.

Requirements for WEEE compliance may include registration of products with local governments, reporting of recycling activities to local governments, and financing of recycling activities.

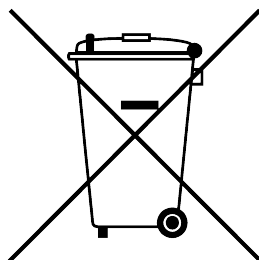

## INSTALLATION

### VISUAL CHECK

After unpacking the instrument, examine to ensure that it has not been damaged in shipment. Visually inspect all connectors, knobs, liquid crystal displays (LCDs), and the handles. If the instrument has been damaged, file a claim immediately with the company that transported the instrument.

The following items should be with the instrument:

- 1) One power cord.
- 2) One GPIB cable
- 3) Two instrumentation manuals (this manual and the “Programming Manual for -B Instruments”).
- 4) One test jig, with a hinged lid.
- 5) One 5 meter length of coaxial cable.
- 6) One 60 cm length of coaxial cable.
- 7) One 2 meter DB-9 control cable.

### POWER RATINGS

This instrument is intended to operate from 100 - 240 V, 50 - 60 Hz.

The maximum power consumption is 74 Watts. Please see the “FUSES” section for information about the appropriate AC and DC fuses.

This instrument is an “Installation Category II” instrument, intended for operation from a normal single-phase supply.

### CONNECTION TO THE POWER SUPPLY

An IEC-320 three-pronged recessed male socket is provided on the back panel for AC power connection to the instrument. One end of the detachable power cord that is supplied with the instrument plugs into this socket. The other end of the detachable power cord plugs into the local mains supply. Use only the cable supplied with the instrument. The mains supply must be earthed, and the cord used to connect the instrument to the mains supply must provide an earth connection. (The supplied cord does this.)

 Warning: Failure to use a grounded outlet may result in injury or death due to electric shock. This product uses a power cord with a ground connection. It must be connected to a properly grounded outlet. The instrument chassis is connected to the ground wire in the power cord.

The table below describes the power cord that is normally supplied with this instrument, depending on the destination region:

Destination Region	Description	Manufacturer	Part Number
Continental Europe	European CEE 7/7 "Schuko" 230V, 50Hz	Qualtek ( <a href="http://www.qualtekusa.com">http://www.qualtekusa.com</a> )	319004-T01
United Kingdom	BS 1363, 230V, 50Hz	Qualtek ( <a href="http://www.qualtekusa.com">http://www.qualtekusa.com</a> )	370001-E01
Switzerland	SEV 1011, 2 30V, 50Hz	Volex ( <a href="http://www.volex.com">http://www.volex.com</a> )	2102H-C3-10
Israel	SI 32, 220V, 50Hz	Volex ( <a href="http://www.volex.com">http://www.volex.com</a> )	2115H-C3-10
North America, and all other areas	NEMA 5-15, 120V, 60 Hz	Qualtek ( <a href="http://www.qualtekusa.com">http://www.qualtekusa.com</a> )	312007-01

## PROTECTION FROM ELECTRIC SHOCK

 Operators of this instrument must be protected from electric shock at all times. The owner must ensure that operators are prevented access and/or are insulated from every connection point. In some cases, connections must be exposed to potential human contact. Operators must be trained to protect themselves from the risk of electric shock. This instrument is intended for use by qualified personnel who recognize shock hazards and are familiar with safety precautions required to avoid possibly injury. In particular, operators should:

1. Keep exposed high-voltage wiring to an absolute minimum.
2. Wherever possible, use shielded connectors and cabling.
3. Connect and disconnect loads and cables only when the instrument is turned off.
4. Keep in mind that all cables, connectors, oscilloscope probes, and loads must have an appropriate voltage rating.
5. Do not attempt any repairs on the instrument, beyond the fuse replacement procedures described in this manual. Contact Avtech technical support (see page 2 for contact information) if the instrument requires servicing. Service is to be performed solely by qualified service personnel.

## ENVIRONMENTAL CONDITIONS

This instrument is intended for use under the following conditions:

1. indoor use;

2. altitude up to 2 000 m;
3. temperature 5 °C to 40 °C;
4. maximum relative humidity 80 % for temperatures up to 31 °C decreasing linearly to 50 % relative humidity at 40 °C;
5. Mains supply voltage fluctuations up to  $\pm 10$  % of the nominal voltage;
6. no pollution or only dry, non-conductive pollution.

## FUSES

This instrument contains four fuses. All are accessible from the rear-panel. Two protect the AC prime power input, and two protect the internal DC power supplies. The locations of the fuses on the rear panel are shown in the figure below:

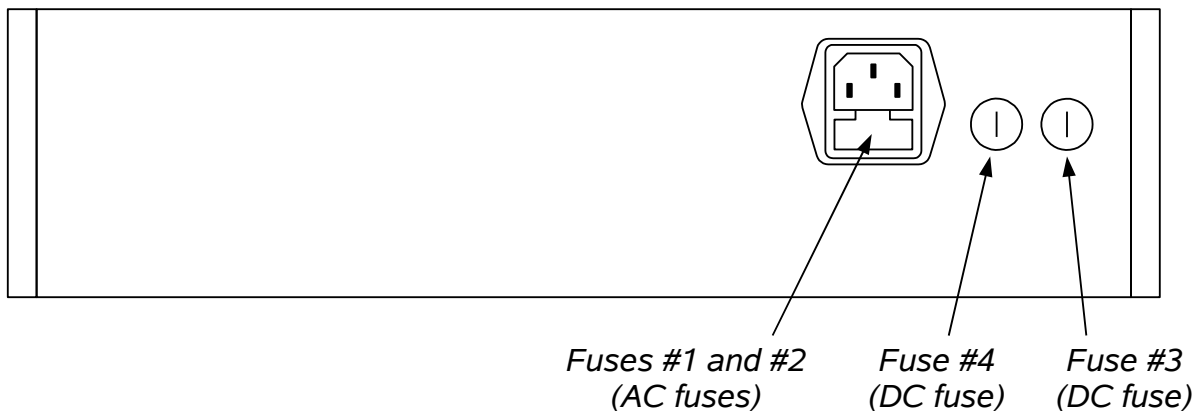

### AC FUSE REPLACEMENT

To physically access the AC fuses, the power cord must be detached from the rear panel of the instrument. The fuse drawer may then be extracted using a small flat-head screwdriver, as shown below:

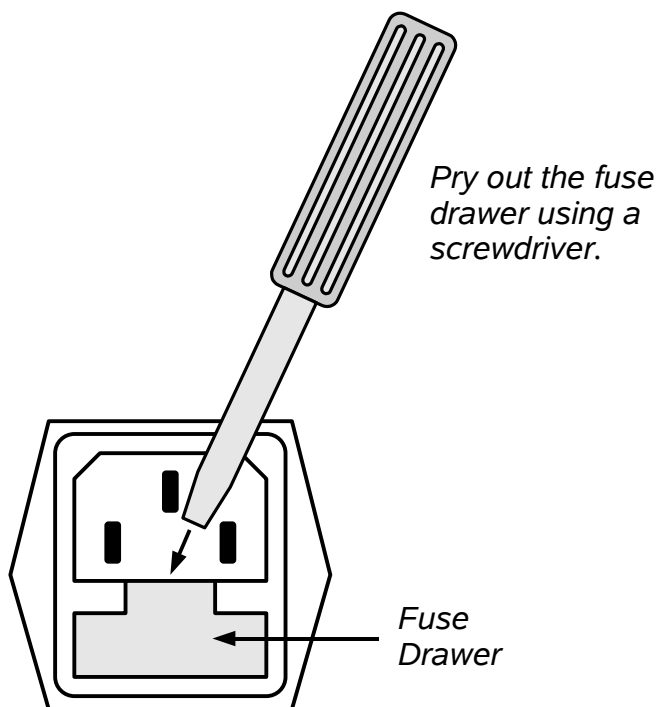

## DC FUSE REPLACEMENT

The DC fuses may be replaced by inserting the tip of a flat-head screwdriver into the fuse holder slot, and rotating the slot counter-clockwise. The fuse and its carrier will then pop out.

## FUSE RATINGS

The following table lists the required fuses:

Fuses	Nominal Mains Voltage	Rating	Case Size	Manufacturer's Part Number (Wickmann)	Distributor's Part Number (Digi-Key)
#1, #2 (AC)	100-240V	0.5A, 250V, Time-Delay	5×20 mm	1950500000	WK5041-ND
#3 (DC)	N/A	1.6A, 250V, Time-Delay	5×20 mm	1951160000	WK5053-ND
#4 (DC)	N/A	0.5A, 250V, Time-Delay	5×20 mm	1950500000	WK5041-ND

The fuse manufacturer is Wickmann (<http://www.wickmann.com/>).

Replacement fuses may be easily obtained from Digi-Key (<http://www.digikey.com/>) and other distributors.

## FRONT PANEL CONTROLS

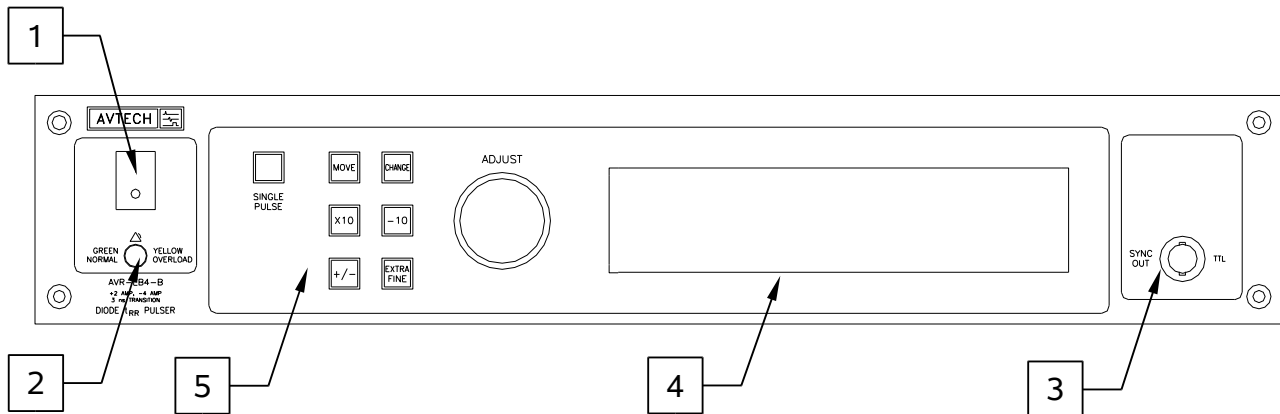

1. **POWER Switch**. This is the main power switch. When turning the instrument on, there may be a delay of several seconds before the instrument appears to respond.
2. **OVERLOAD Indicator**. When the instrument is powered, this indicator is normally green, indicating normal operation. If this indicator is yellow, an internal automatic overload protection circuit has been tripped. If the unit is overloaded (by operating at an exceedingly high duty cycle or by operating into a very low impedance), the protective circuit will disable the output of the instrument and turn the indicator light yellow. The light will stay yellow (i.e. output disabled) for about 5 seconds after which the instrument will attempt to re-enable the output (i.e. light green) for about 1 second. If the overload condition persists, the output will be disabled again (i.e. light yellow) for another 5 seconds. If the overload condition has been removed, the instrument will resume normal operation.  
  
This overload indicator may flash yellow briefly at start-up. This is not a cause for concern.
3. **SYNC OUT**. This connector supplies a SYNC output that can be used to trigger other equipment, particularly oscilloscopes. This signal leads (or lags) the main output by a duration set by the "DELAY" controls and has an approximate amplitude of +3 Volts to  $R_L > 50\Omega$  with a pulse width of approximately 100 ns.
4. **LIQUID CRYSTAL DISPLAY (LCD)**. This LCD is used in conjunction with the keypad to change the instrument settings. Normally, the main menu is displayed, which lists the key adjustable parameters and their current values. The "Programming Manual for -B Instruments" describes the menus and submenus in detail.



5. KEYPAD.

Control Name	Function
MOVE	This moves the arrow pointer on the display.
CHANGE	This is used to enter the submenu, or to select the operating mode, pointed to by the arrow pointer.
×10	If one of the adjustable numeric parameters is displayed, this increases the setting by a factor of ten.
÷10	If one of the adjustable numeric parameters is displayed, this decreases the setting by a factor of ten.
+/-	If one of the adjustable numeric parameters is displayed, and this parameter can be both positive or negative, this changes the sign of the parameter.
EXTRA FINE	This changes the step size of the ADJUST knob. In the extra-fine mode, the step size is twenty times finer than in the normal mode. This button switches between the two step sizes.
ADJUST	This large knob adjusts the value of any displayed numeric adjustable values, such as frequency, pulse width, etc. The adjust step size is set by the "EXTRA FINE" button.  When the main menu is displayed, this knob can be used to move the arrow pointer.

## REAR PANEL CONTROLS

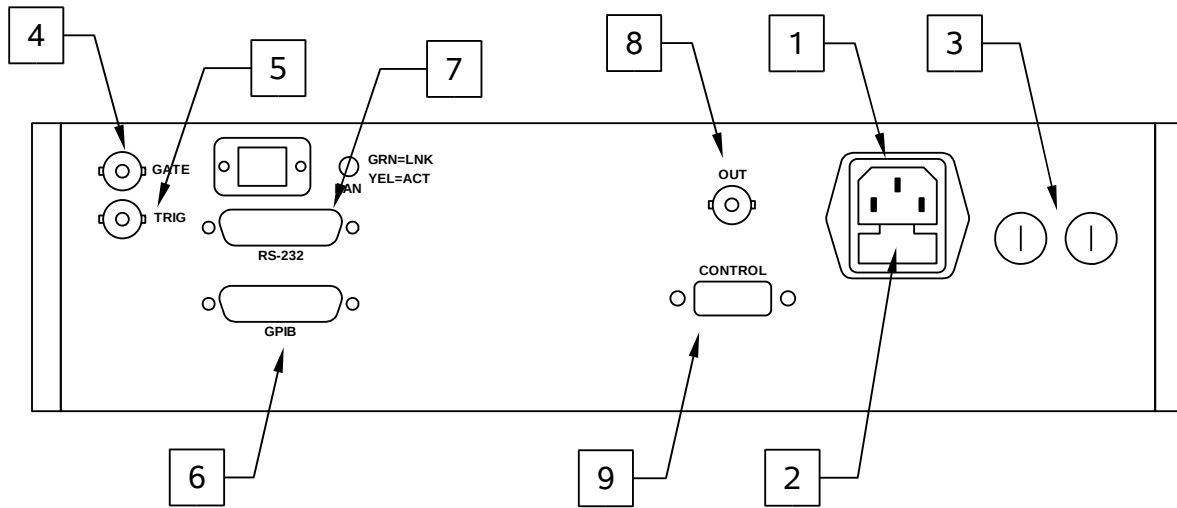

1. AC POWER INPUT. An IEC-320 C14 three-pronged recessed male socket is provided on the back panel for AC power connection to the instrument. One end of the detachable power cord that is supplied with the instrument plugs into this socket.
2. AC FUSE DRAWER. The two fuses that protect the AC input are located in this drawer. Please see the “FUSES” section of this manual for more information.
3. DC FUSES. These two fuses protect the internal DC power supplies. Please see the “FUSES” sections of this manual for more information.
4. GATE. This TTL-level (0 and +5V) logic input can be used to gate the triggering of the instrument. This input can be either active high or active low, depending on the front panel settings or programming commands. (The instrument triggers normally when this input is unconnected). When set to active high mode, this input is pulled-down to ground by a 1 k $\Omega$  resistor. When set to active low mode, this input is pulled-up to +5V by a 1 k $\Omega$  resistor.
5. TRIG. This TTL-level (0 and +5V) logic input can be used to trigger the instrument, if the instrument is set to triggering externally. The instrument triggers on the rising edge of this input. The input impedance of this input is 1 k $\Omega$ . (Depending on the length of cable attached to this input, and the source driving it, it may be desirable to add a coaxial 50 Ohm terminator to this input to provide a proper transmission line termination. The Pasternack ([www.pasternack.com](http://www.pasternack.com)) PE6008-50 BNC feed-thru 50 Ohm terminator is suggested for this purpose.)
6. GPIB Connector. A standard GPIB cable can be attached to this connector to allow the instrument to be computer-controlled. See the “Programming Manual for -B Instruments” for more details on GPIB control.

7. RS-232 Connector. A standard serial cable with a 25-pin male connector can be attached to this connector to allow the instrument to be computer-controlled. See the “Programming Manual for -B Instruments” for more details on RS-232 control.
8. PULSE OUT CONNECTOR. This BNC connector provides the pulse output signal to the test jig. This output should be connected to the corresponding input on the test jig using one of the the supplied coaxial cables (60 cm or 5 m).

 Caution: Voltages as high as 240V may be present on the center conductor of this output connector. Avoid touching this conductor. Connect to this connector using standard coaxial cable, to ensure that the center conductor is not exposed.

9. CONTROL Connector. This DB-9 female connector should be connected to the corresponding connector on the test jig using the supplied DB-9 cable. This cable contains the safety interlock signals that ensure that the test jig lid is closed. The pinout is as follows:

Pin 1 - To test jig switch 1.

Pin 2 - To test jig switch 2.

Pin 5 - Ground.

Pin 6 - To test jig switch 1.

Pin 7 - To test jig switch 2.

Pin 9 - Safety sensor power supply (+15V through 680 Ohms).

When the test jig lid is safely closed, Pin 1 is shorted to Pin 6, and Pin 2 is shorted to Pin 7.

## TIMING CONTROL

### BASIC TIMING CONTROL

This instrument can be triggered by its own internal clock or by an external TTL trigger signal. In either case, two output channels respond to the trigger: PULSE and SYNC.

The PULSE output is a bipolar signal that may either drive a 50 Ohm load, or the test jig described later. The positive and negative amplitudes are adjustable. The pulse widths are variable over a 2-20 us range.

The SYNC pulse is a fixed-width TTL-level reference pulse used to trigger oscilloscopes or other measurement systems. When the delay is set to a positive value the SYNC pulse precedes the PULSE output. When the delay is set to a negative value the SYNC pulse follows the PULSE output.

These pulses are illustrated below, assuming internal triggering and a positive delay:

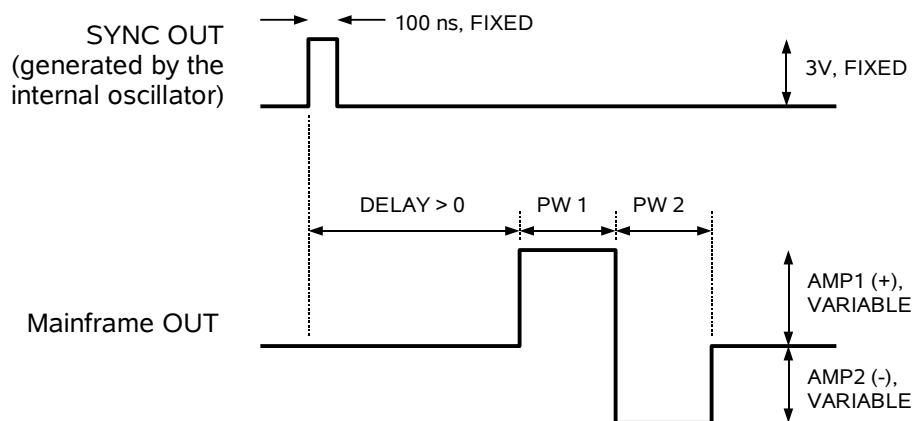

*Figure A*

If the delay is negative, the order of the SYNC and PULSE outputs is reversed:

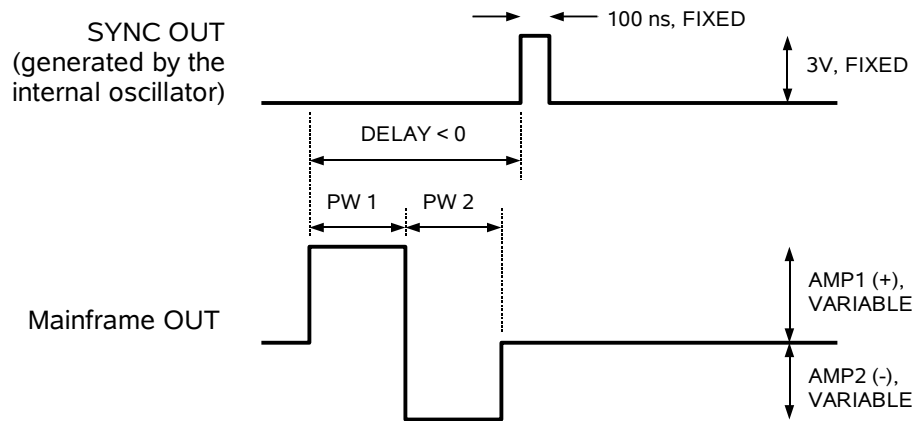

Figure B

The next figure illustrates the relationship between the signal when an external TTL-level trigger is used:

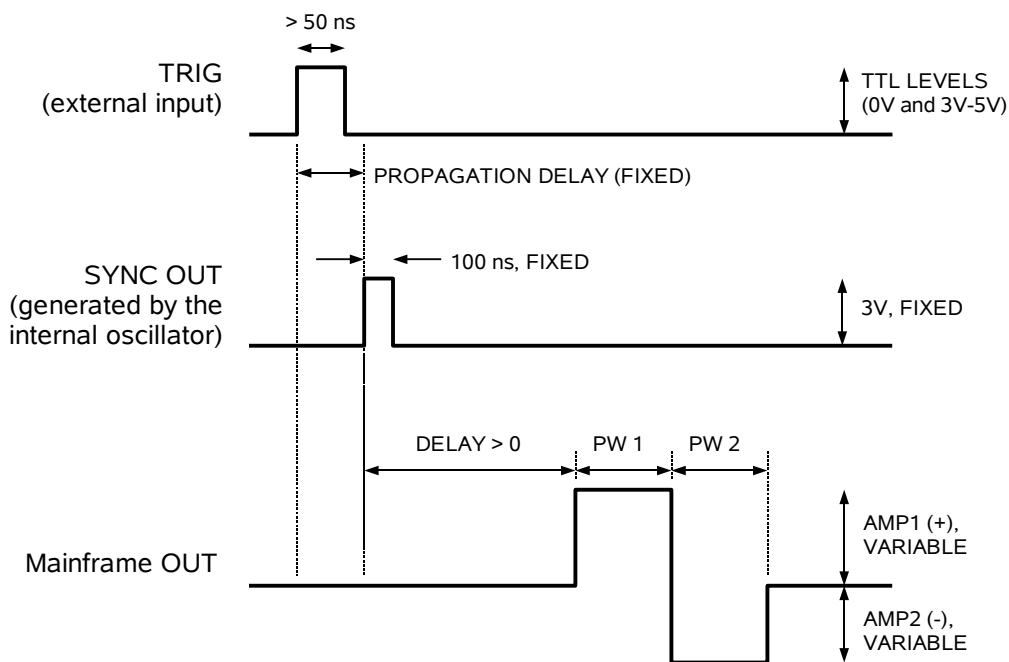

Figure C

As before, if the delay is negative, the order of the SYNC and PULSE outputs is reversed.

The delay and frequency (when in the internal mode) of the PULSE output can be varied with front panel controls or via the GPIB or RS-232 computer interfaces.

## TRIGGER MODES

This instrument has four trigger modes:

- Internal Trigger: the instrument controls the trigger frequency, and generates the clock internally.
- External Trigger: the instrument is triggered by an external TTL-level clock on the back-panel TRIG connector.
- Manual Trigger: the instrument is triggered by the front-panel “SINGLE PULSE” pushbutton.
- Hold Trigger: the instrument is set to not trigger at all.

These modes can be selected using the front panel trigger menu, or by using the appropriate programming commands. (See the “Programming Manual for -B Instruments” for more details.)

## GATING MODES

Triggering can be suppressed by a TTL-level signal on the rear-panel GATE connector. The instrument can be set to stop triggering when this input high or low, using the front-panel gate menu or the appropriate programming commands. When gated, the output will complete the full pulse width if the output is high, and then stop triggering. Pulses are not truncated.

## BASIC AMPLITUDE CONTROL

The basic test arrangement for the AVR-EB4-B is shown in the figure below. The PULSE output on the instrument mainframe is connected to the PULSE input on the test jig (model AVX-TRR-MIX, or a customized variant) using the supplied coaxial cable, and the control cable is connected using the supplied DB-9 cable.

⚠ Normally, the 60 cm / 2 foot-long coaxial cable should be used, except when reflections are observed on the output waveform.

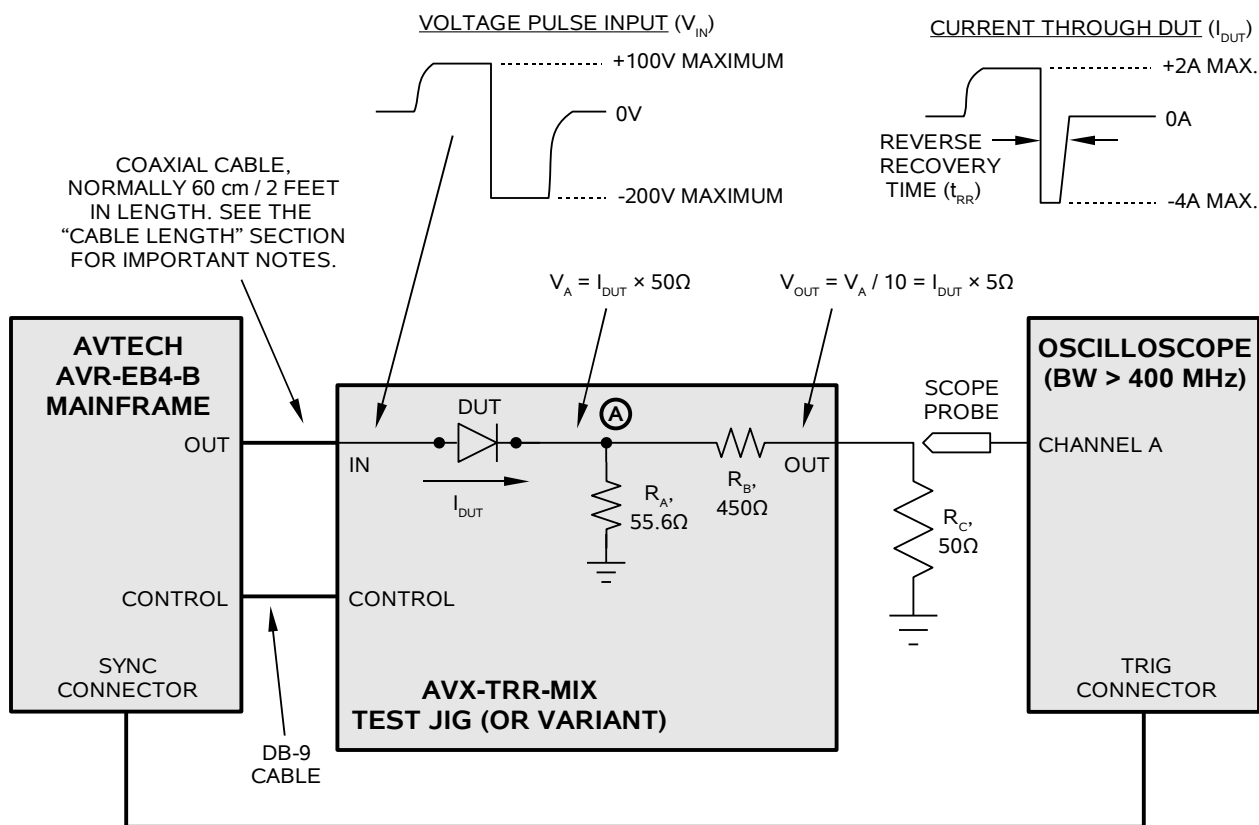

⚠ A 50 Ohm resistance ( $R_C$  in the diagram above) must be connected to ground on the output. This can be a discrete resistor, a feed-through terminator, or the input impedance of an oscilloscope. If a high-speed sampling oscilloscope is used, the input should be protected by adding attenuator on the input.

The total effective resistance of resistors  $R_A$ ,  $R_B$ , and  $R_C$  in the diagram above is 50 Ohms. Thus, the voltage at point "A" is simply given by:

$$V_A = I_{DUT} \times 50\Omega$$

where  $I_{DUT}$  is the current through the device under test. A 450 Ohm resistance ( $R_B$ ) is present in series with the measurement output. When a 50 Ohm resistance ( $R_C$ ) is installed on the output (by the user), the output voltage will be one-tenth of  $V_A$  due to the resistor-divider effect. That is:

$$V_{OUT} = V_A / 10 = I_{DUT} \times 5\Omega$$

This is the key equation for relating the observed voltage waveform to the DUT current.

### SETTING THE AMPLITUDE LEVELS

The amplitude of the positive and negative portions of the PULSE waveform may be set from the front panel of the instrument, or by computer command. These settings are expressed in terms of the voltage present on the test jig input.

The positive voltage ("AMP1" on the front panel display) is related to the forward diode current by:

$$I_{FORWARD} \approx (AMP1 - V_F) / (50\Omega + R_{DIODE-FORWARD})$$

where  $V_F$  is the forward voltage drop of the diode (typically 0.7V for the classic silicon PN junction diode, and usually somewhat lower for a Schottky diode), and  $R_{DIODE-FORWARD}$  is the effective resistance of the diode under forward bias.

The negative voltage ("AMP2" on the front panel display) is related to the reverse diode current by:

$$I_{REVERSE} \approx AMP2 / (50\Omega + R_{DIODE-REVERSE}).$$

Where  $R_{DIODE-REVERSE}$  is the effective resistance of the diode under reverse bias.

It is important to note that  $R_{DIODE-FORWARD}$  and  $R_{DIODE-REVERSE}$  are not the same, and that they may change during the transient. Furthermore, depending on the design of the diode under test, it is possible that  $R_{DIODE-REVERSE}$  may be so high that it is impossible to achieve the full 4 Amps of reverse current. (The ideal diode would of course have  $R_{DIODE-REVERSE} = \infty$ ). The reverse voltage can actually be increased to -240V (rather than the nominal maximum of -200V) to increase the likelihood of obtaining the full 4 Amps of reverse current.

Most test procedures for measuring recovery time will use a particular ratio of forward to reverse currents - for example,  $I_{REVERSE} / I_{FORWARD} = 2$ .

Some Schottky diodes have negligible amounts of stored charge resulting from the forward bias, compared to non-Schottky devices. For these Schottky diodes, the reverse transient will be governed by the capacitance of the device, and the reverse transient may be largely unaffected by the amplitude of the forward transient. (In other



words, the  $I_{\text{REVERSE}} / I_{\text{FORWARD}}$  ratio is irrelevant). The capacitance may be so small that it becomes impossible to obtain the full -4 Amps of reverse current.

Normally, the forward and reverse amplitudes should be set near the maximum values (+100V, -200V). Performance may degrade if the amplitudes are set lower than 10% of the maximum values.

### AMPLITUDE ACCURACY

Due to the variations in  $V_F$  and  $R_{\text{DIODE-FORWARD}}$  and  $R_{\text{DIODE-REVERSE}}$  as a function of operating conditions, the AMP1 and AMP2 settings *should not be relied upon for any degree of accuracy*. Instead the voltage at the OUT terminal on the test jig should be monitored with a calibrated oscilloscope. As mentioned above,  $I_{\text{DUT}} = V / 5\Omega$ .

$R_A$  and  $R_B$  can be measured directly on the test jig (with the test jig disconnected) to determine calibrated relationships, if desired.  $R_C$  is provided by the user, and can be calibrated as required.

### INCORRECT ORIENTATION

The instrument and the DUT will not be damaged if the diode is installed with the incorrect orientation (i.e., with the anode and cathode reversed). However, incorrect waveforms will be generated,

### CABLE LENGTHS

The test jig is connected to the mainframe using two cables:

- 1) A 2-meter-long DB-9 control cable
- 2) A coaxial cable.

The length of the coaxial cable affects the measured waveform slightly. The cable length should be chosen based on the type of diode that will be tested.

 Normally, the 60 cm / 2 foot-long coaxial cable should be used, except when reflections are observed on the output waveform.

However, diodes with extremely short recovery times (< 10 ns), like ultra-fast Schottky diodes, or diodes with “step recovery” or “hard switching” characteristics, may generate noticeable reflections after the end of the reverse transient. If these reflections overlap with the transient itself, a longer cable should be used. This will increase the period of the reflections, placing them well after the transient where they may be ignored. A 5-meter-long cable is supplied for this purpose.

 For “soft-switching” diodes, the shortest possible cable length should be used. The 60-cm-long coaxial cable should be used for these applications. When a “soft switching” diode nears the end of its reverse transient, the diode turns off more gradually. This does not produce reflections, but the impedance mismatch that slowly develops means that the attached cable acts as a capacitance. This tends to extend the waveform slightly, leading to a small (~10%) over-estimation of the reverse recovery time.

In summary, the shortest possible coaxial cabling should be used, except when “hard switching” causes noticeable reflections. In that case, use longer cable lengths.

Example waveforms are included in the “TYPICAL RESULTS” section.

### ACCESSIBLE VOLTAGES

The mainframe provides pulsed voltages of up to 240V to the test jig. For this reason, the output is automatically disabled when the test jig lid is open. The lid must be closed to obtain measurements.

 Shielded cabling should be used for all connections to the "IN" and "OUT" terminals on the test jig, and the "OUT" connector on the mainframe.

 When used properly (with  $R_C = 50$  Ohms), the maximum voltage on the OUT terminal will be 24V, approximately. However, if  $R_C$  is not connected, the maximum voltage will at the OUT terminal may be as high as 240V. Avoid feeding this output directly into an oscilloscope. Always use a probe or an attenuator!

## STANDARD TEST JIG MECHANICAL ASPECTS

One AVX-TRR-MIX test jig is normally supplied with the mainframe, unless the customer has requested a different or additional test jigs.

### AVX-TRR-MIX TEST JIG

The AVX-TRR-MIX test jig accepts a range of through-hole and axial devices, using pin sockets and spring-loaded pins. It is intended for use with diodes in DO-41, TO-220, DO-204AR, TO-3 or similar packages. A photo of the arrangement is shown below:

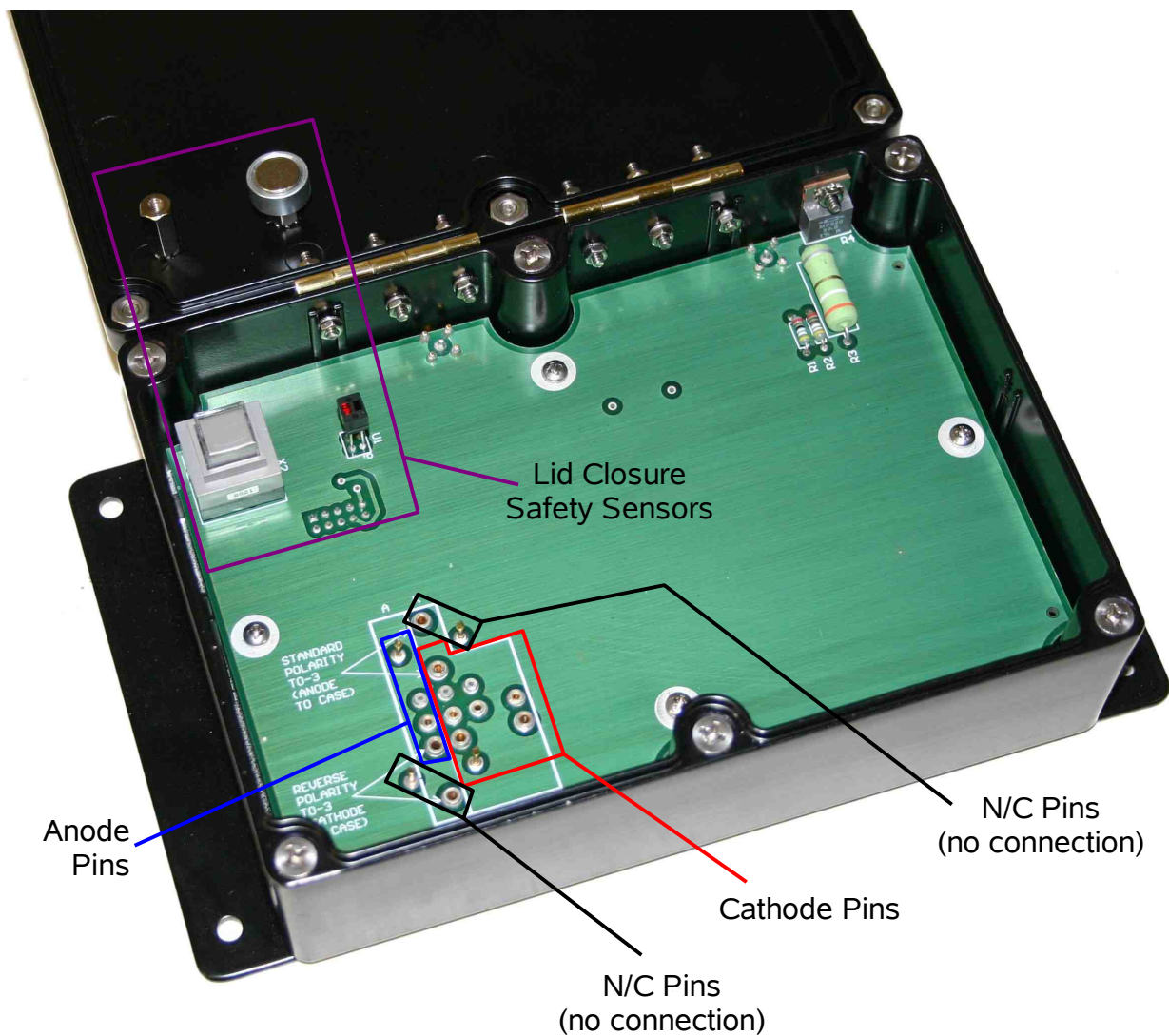

The instrument and the DUT will not be damaged if the diode is installed with the incorrect orientation (i.e., with the anode and cathode reversed). However, incorrect waveforms will be generated.

The procedure for inserting most axial and TO-220 packages is straightforward. Simply insert the DUT between one of the Anode pin sockets (in the blue area above) and one of the Cathode sockets (in the red area above). Select the sockets with the most appropriate hole size, and try to minimize all lead lengths, to minimize parasitic inductance.

This jig will also accommodate a number of TO-3 configurations, outlined below. If the case is connected to the anode, and the pin(s) are used for the cathode, the arrangement shown below must be used:

This socket and spring pin provide mechanical support only. They are not electrically active.

This spring pin must contact the underside of the case. It provides the anode connection.

The cathode pin of interest must be inserted into this socket. For dual-diode devices, rotate the TO-3 package so that the desired diode cathode is inserted here.

***For TO-3 packages  
with Case = Anode***

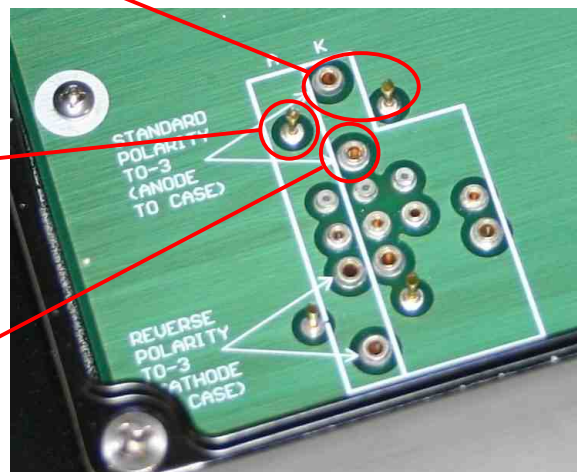

If the case is connected to the cathode, and the pin(s) are used for the anode, the arrangement shown below must be used:

**For TO-3 packages  
with Case = Cathode**

The anode pin of interest must be inserted into this socket. For dual-diode devices, rotate the TO-3 package so that the desired diode anode is inserted here.

This socket and spring pin provide mechanical support only. They are not electrically active.

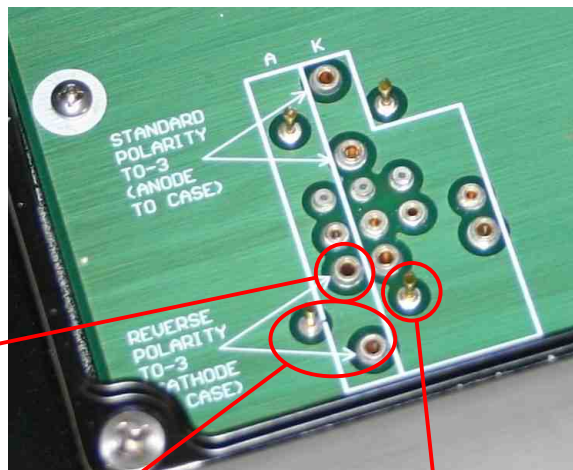

This spring pin must contact the underside of the case. It provides the cathode connection.

The IN, OUT, and CONTROL connectors are on the rear of the jig, below the hinges:



## TYPICAL RESULTS

Obtaining meaningful results with the AVR-EB4-B requires care, experience, and an understanding of diode transient behavior and the impact of inductive and capacitive parasitics. To assist the user, typical results for commercially available diodes are provided below. The user should be able to reliably duplicate these results.

### 1N4937 RESULTS

The On Semiconductor 1N4937 is a 1A, 600V DO-41 fast-recovery rectifier. With the amplitudes set to +100V and -200V, and with the mainframe connected to the test jig using a 60 cm coaxial cable, the following reverse recovery waveform is obtained at the test jig "OUT" terminal:

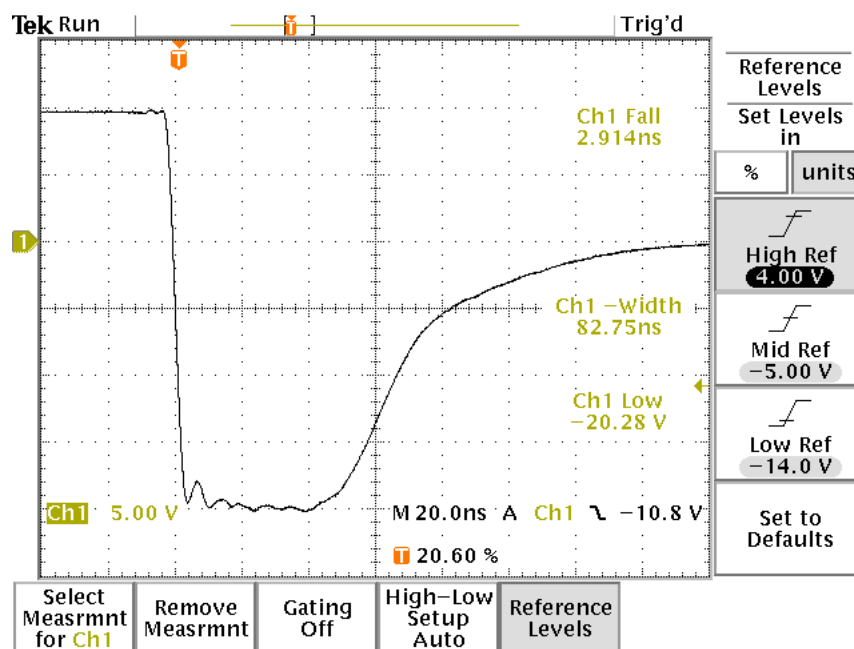

5 V/div (= 1 A/div), 20 ns/div.  
20%-80% switching time shown.  
S/N 11713. 60 cm cable used.

The above waveform shows the transition from a forward current of +2A to a reverse current of -4A. The reverse transient lasts for approximately 82.75 ns under these conditions (measured at the 25% reverse current point).

For this test, the 1N4937 was installed as shown below:

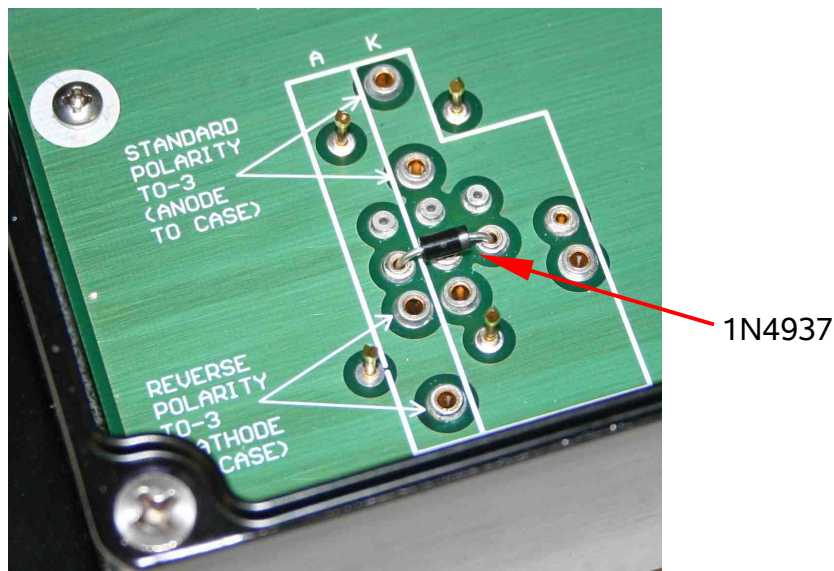

This transient shows a “soft-switching” recovery, and no reflections are observed at the end of the transient, so the 60 cm coaxial cable was used. If the 5 m cable is used, the measured recovery time will be too high, as shown below:

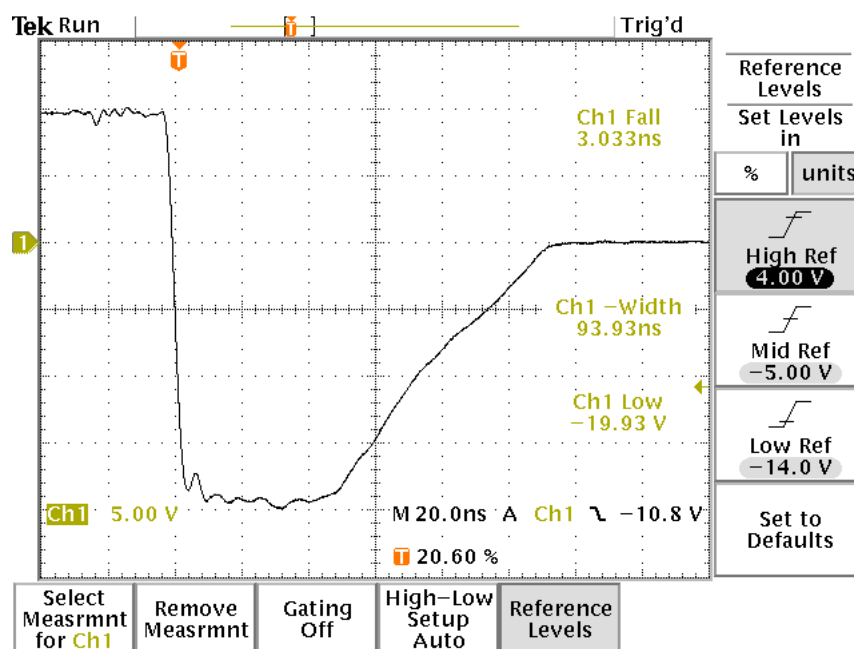

5 V/div (= 1 A/div), 20 ns/div.  
20%-80% switching time shown.  
S/N 11713. 5m cable used.

The use of the incorrect cable boost the observed recovery time from ~ 83ns to ~ 94 ns.



## J5418 RESULTS

The Microsemi J5418 was tested with amplitudes set to +100V and -200V, and with the mainframe connected to the test jig using a 60 cm coaxial cable. The following reverse recovery waveform was obtained at the test jig "OUT" terminal:

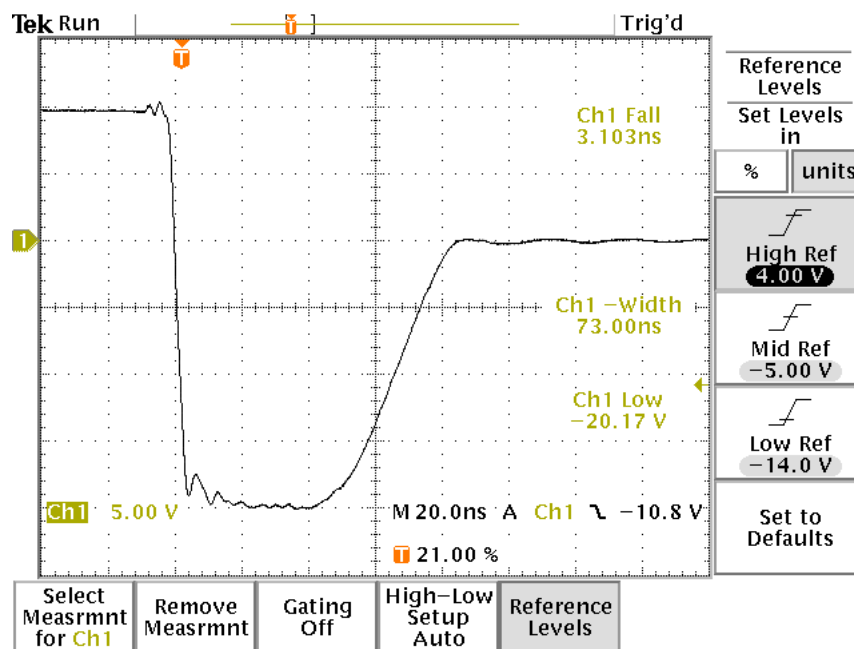

5 V/div (= 1 A/div), 20 ns/div.  
 20%-80% switching time shown.  
 S/N 11713. 60 cm cable used.

The above waveform shows the transition from a forward current of +2A to a reverse current of -4A. The reverse transient lasts for approximately 73 ns under these conditions (measured at the 25% reverse current point).

This diode was also tested under +1A / -2A conditions, which produced a nearly identical figure for  $t_{RR}$ :



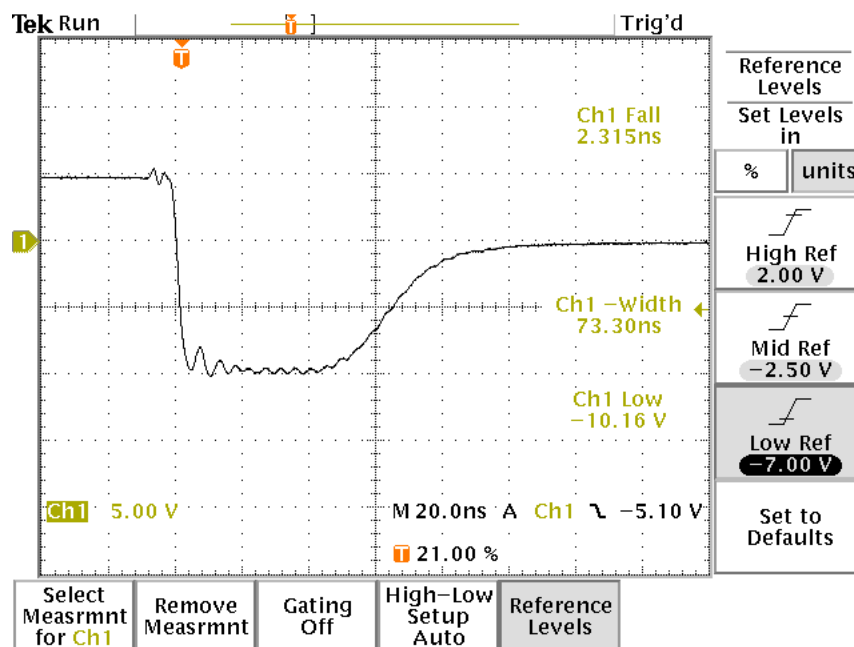

5 V/div (= 1 A/div), 20 ns/div.  
 20%-80% switching time shown.  
 S/N 11713. 60 cm cable used.

In this case, 73.3 ns was measured for +1A/-2A, versus 73.0 ns for +2A/-4A.

### 1N4004 RESULTS

The generic 1N4004 is a very slow 1A, 400V DO-41 fast-recovery rectifier. With the amplitudes set to +100V and -200V, the following reverse recovery waveform is obtained at the test jig "OUT" terminal:

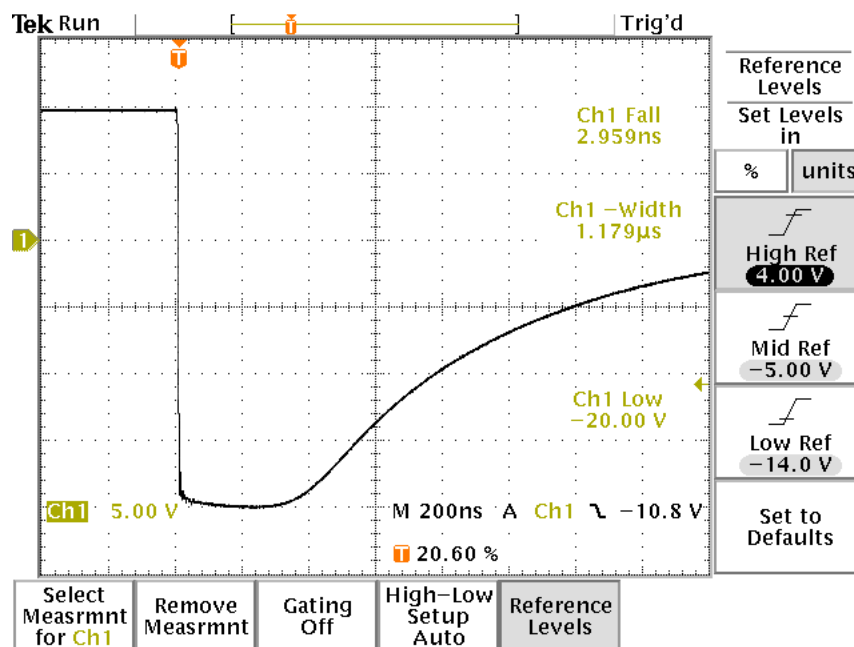

5 V/div (= 1 A/div), 200 ns/div.  
 20%-80% switching time shown.  
 S/N 11713. 60 cm cable used.

The above waveform shows the transition from a forward current of +2A to a reverse current of -4A. The reverse transient duration exceeds 1  $\mu$ s under these conditions.

### MUR8100E RESULTS

The On Semiconductor MUR8100E is a 8A, 1000V TO-220 ultrafast rectifier. With the amplitudes set to +100V and -200V, the following reverse recovery waveform is obtained at the test jig "OUT" terminal:

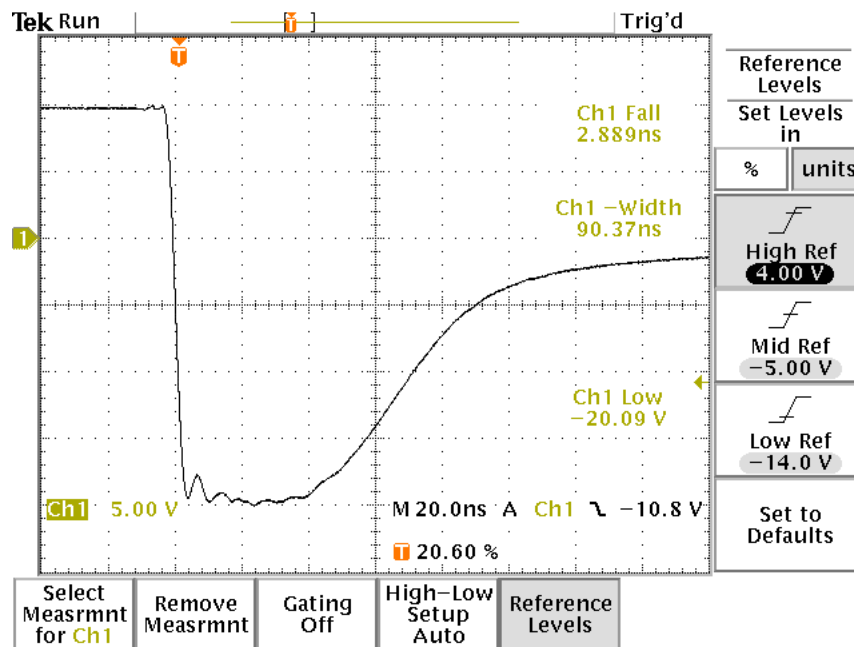

5 V/div (= 1 A/div), 20 ns/div.  
20%-80% switching time shown.  
S/N 11713. 60 cm cable used.

The above waveform shows the transition from a forward current of +2A to a reverse current of -4A. The reverse transient lasts for approximately 90 ns under these conditions.

For this test, the MUR8100E was installed as shown below:

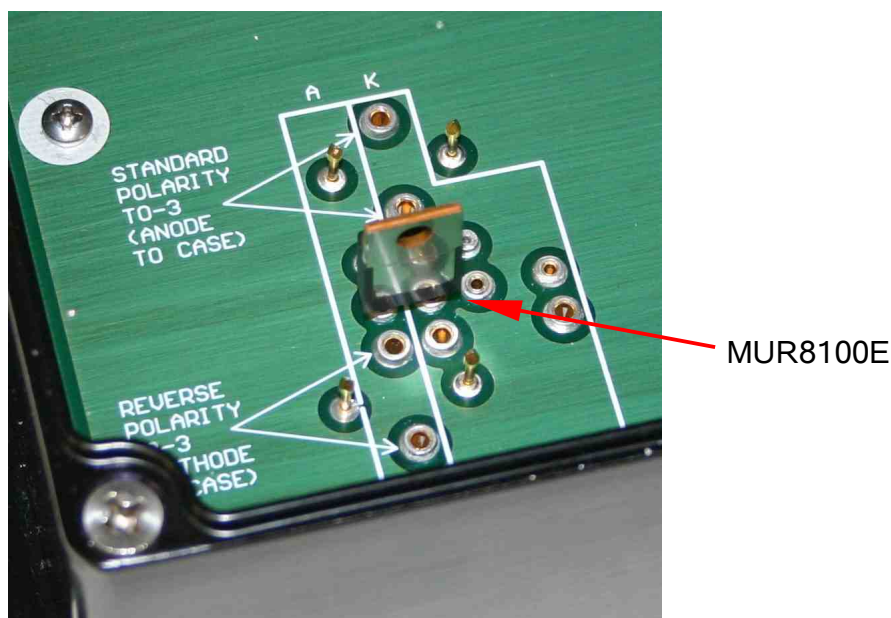

## RUS460 RESULTS

The EDI RUS460 is a 5A, 600V DO-204AR ultrafast rectifier. With the amplitudes set to +100V and -200V, the following reverse recovery waveform is obtained at the test jig "OUT" terminal:

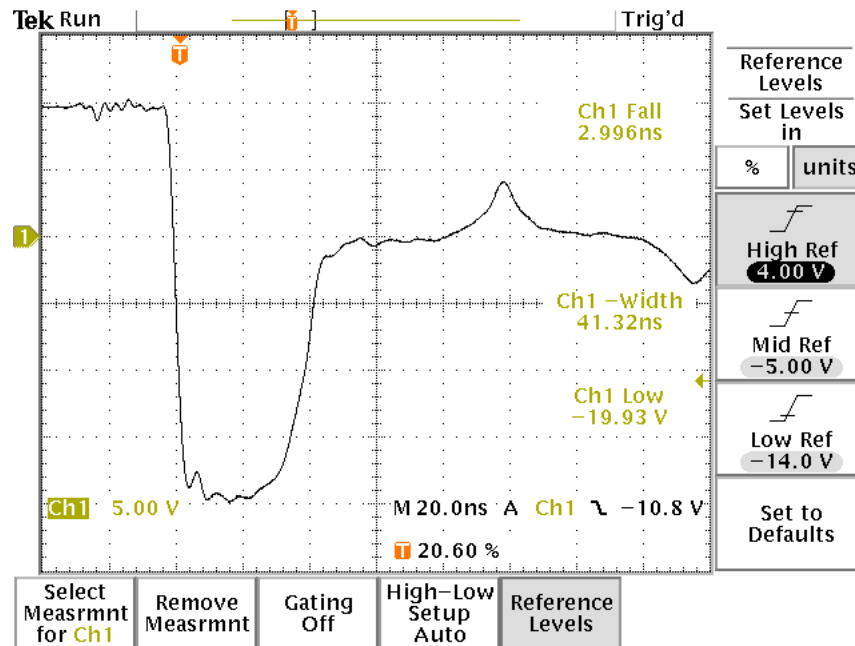

5 V/div (= 1 A/div), 20 ns/div.  
 20%-80% switching time shown.  
 S/N 11713. 5m cable used.

The above waveform shows the transition from a forward current of +2A to a reverse current of -4A. The reverse transient lasts for approximately 40 ns under these conditions, and then ends rather abruptly. This abrupt termination of the reverse transient is somewhat unusual, and is referred to as a "hard" or "step" transient. Most modern diodes are optimized to provide a "soft" transient, with a more gradual decay of the reverse current from its peak value to zero.

The fast switching time of the hard transient causes transmission line reflections to occur. These reflections repeat in an exponential decay pattern, until they are no longer detectable. The time between reflections is governed by the length of coaxial cabling (normally 5 meters) connecting the mainframe to the output module. These reflections can normally be ignored, since they occur after the end of the "interesting" part of the transient where measurements are made. The coaxial cable can be extended to move the reflection away from the switching transient.

In this test, a 5m coaxial cable was used. If the 60 cm cable were used, the following waveform would be obtained:

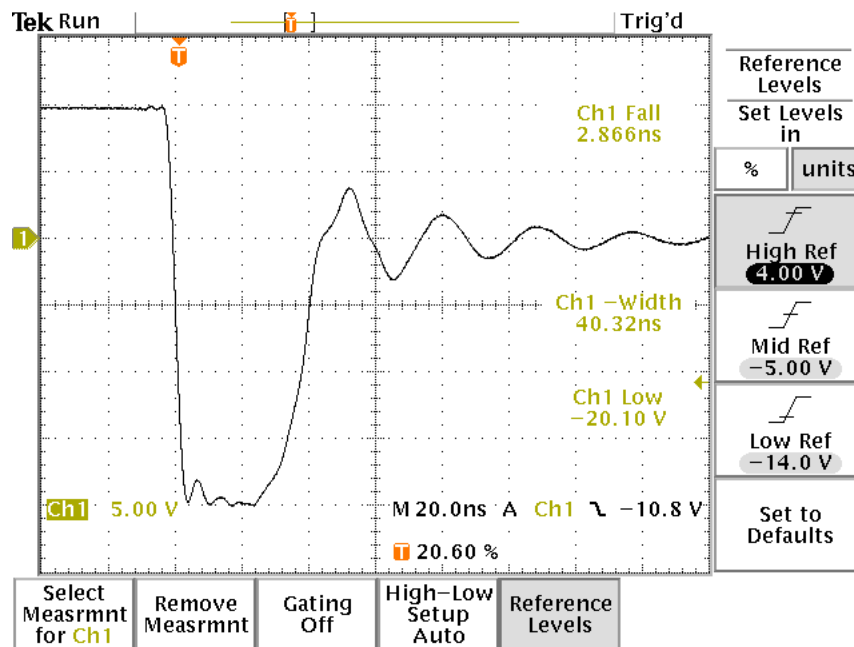

5 V/div (= 1 A/div), 20 ns/div.  
20%-80% switching time shown.  
S/N 11713. 60 cm cable used.

With the 60 cm cable, the measured recovery time is nearly the same as before, but the reflections overlap the transient. In this case, it is best to use the 5m, to clearly separate the two effects (recovery versus reflections).

For this test, the RUS460 was installed as shown below:

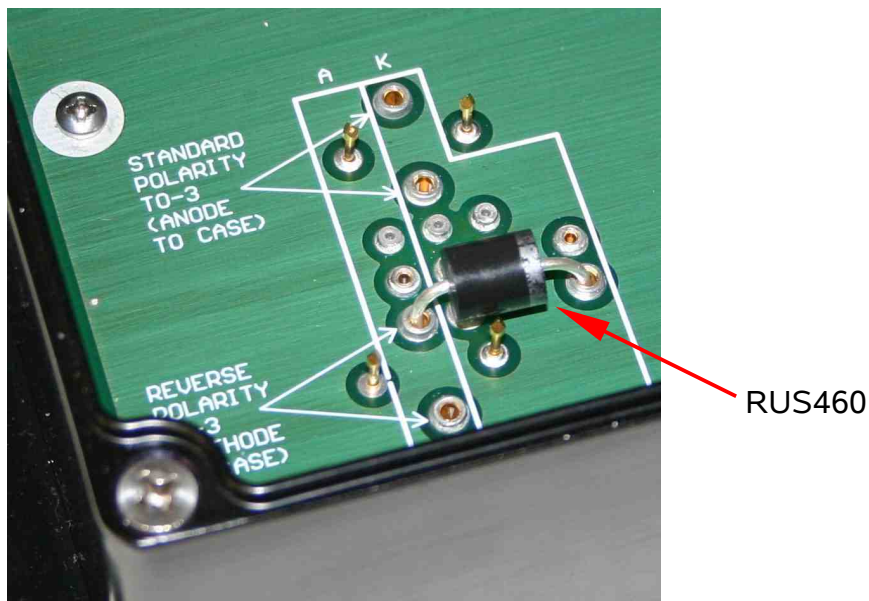

## CSD10120 RESULTS

The Cree CSD10120 is a state-of-the-art 1200 Volt, 10 Amp TO-220-packaged Silicon Carbide Schottky diode, promoted as a "Zero Recovery Rectifier". The waveform below shows the results obtained with the CSD10120 diode installed in the AVX-TRR-MIX test jig:

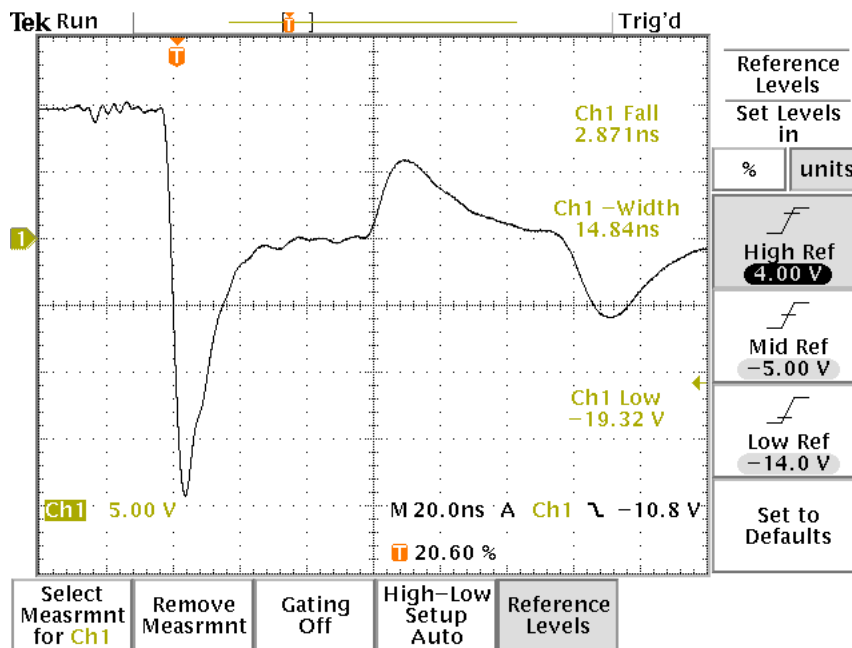

5 V/div (= 1 A/div), 20 ns/div.  
 20%-80% switching time shown.  
 S/N 11713. 5m cable used.

The 5 m cable was used, due to the presence of reflections on the output waveform.

Unlike most conventional diodes, the CSD10120 reverse recovery transient is dominated by the capacitance of the device, rather than by minority carrier charge storage. This can be seen by reducing the forward bias current to zero, as shown below:

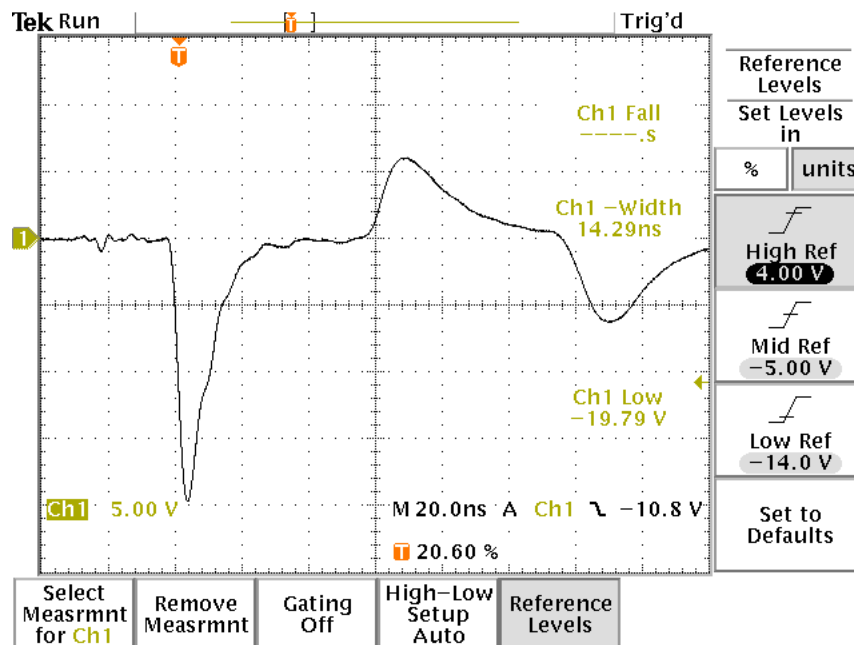

5 V/div (= 1 A/div), 20 ns/div.  
 20%-80% switching time shown.  
 S/N 11713. 5m cable used.

The above waveform shows the transition from a forward current of +0A to a reverse current of -4A, approximately. The reverse transient is nearly unchanged, relative to the case when the forward current was +2A! The CSD10120 datasheet says "this is a majority carrier diode, so there is no reverse recovery charge", and the results above largely support this.

## UTG8042 RESULTS

The Microsemi UTG8042 is a dual ultrafast rectifier in a TO-3 package. With the amplitudes set to +100V and -200V, the following reverse recovery waveform is obtained at the test jig "OUT" terminal:

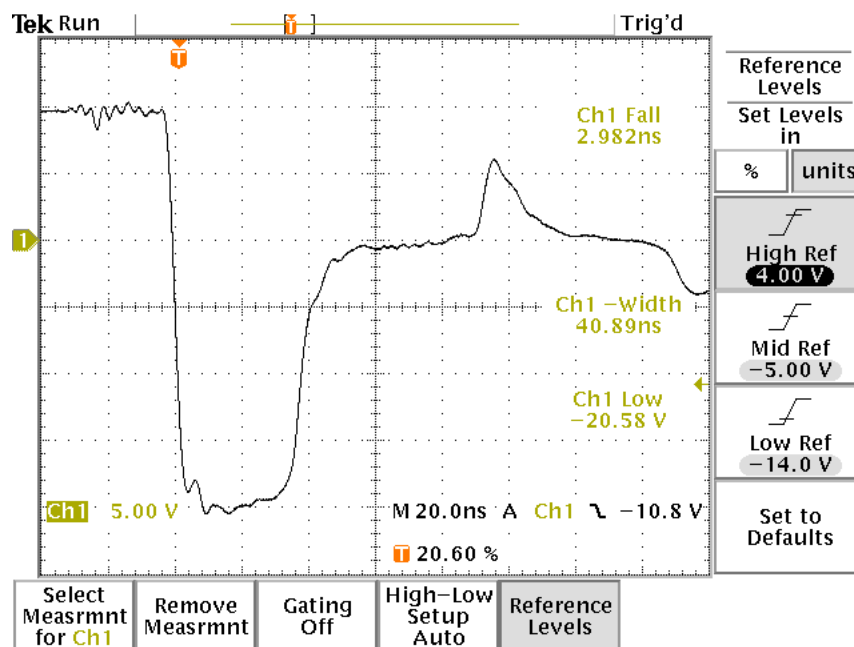

5 V/div (= 1 A/div), 20 ns/div.  
 20%-80% switching time shown.  
 S/N 11713. 5m cable used.

The above waveform shows the transition from a forward current of +2A to a reverse current of -4A. The reverse transient lasts for approximately 41 ns under these conditions, and then ends rather abruptly, causing reflections. The 5m cable was used to ensure that the reflections occur well after the end of the transient.

For this test, the UTG8042 was installed as shown below:

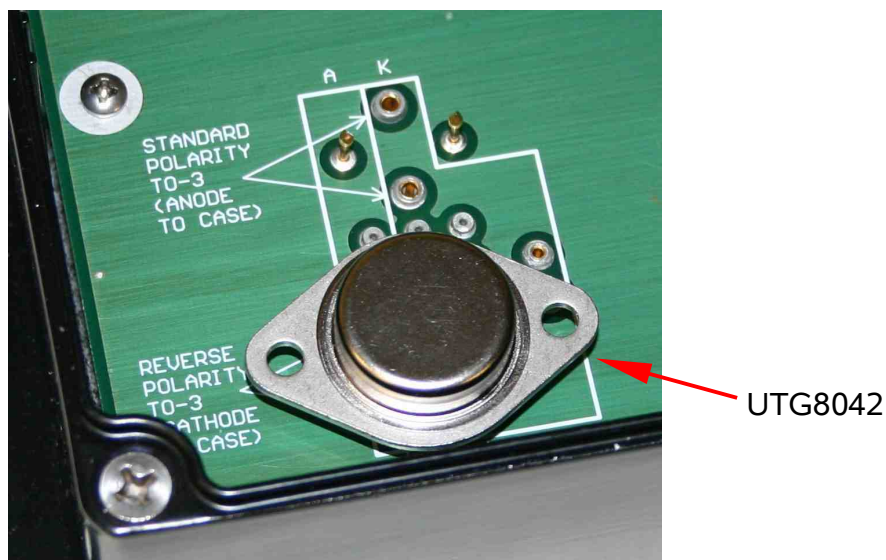

The UTG8042 has two diodes in it. For this test, only the "A" diode was tested.



## SPECIALIZED TEST JIGS

### AXIAL NO-BEND JIGS

Units with the -ANB option with serial numbers 12252 and higher include a jig (AVX-TRR-AXPOST) with two spring-loaded push posts, into which an unbent axial-leaded device may be inserted. The AVX-TRR-AXPOST is shown below:

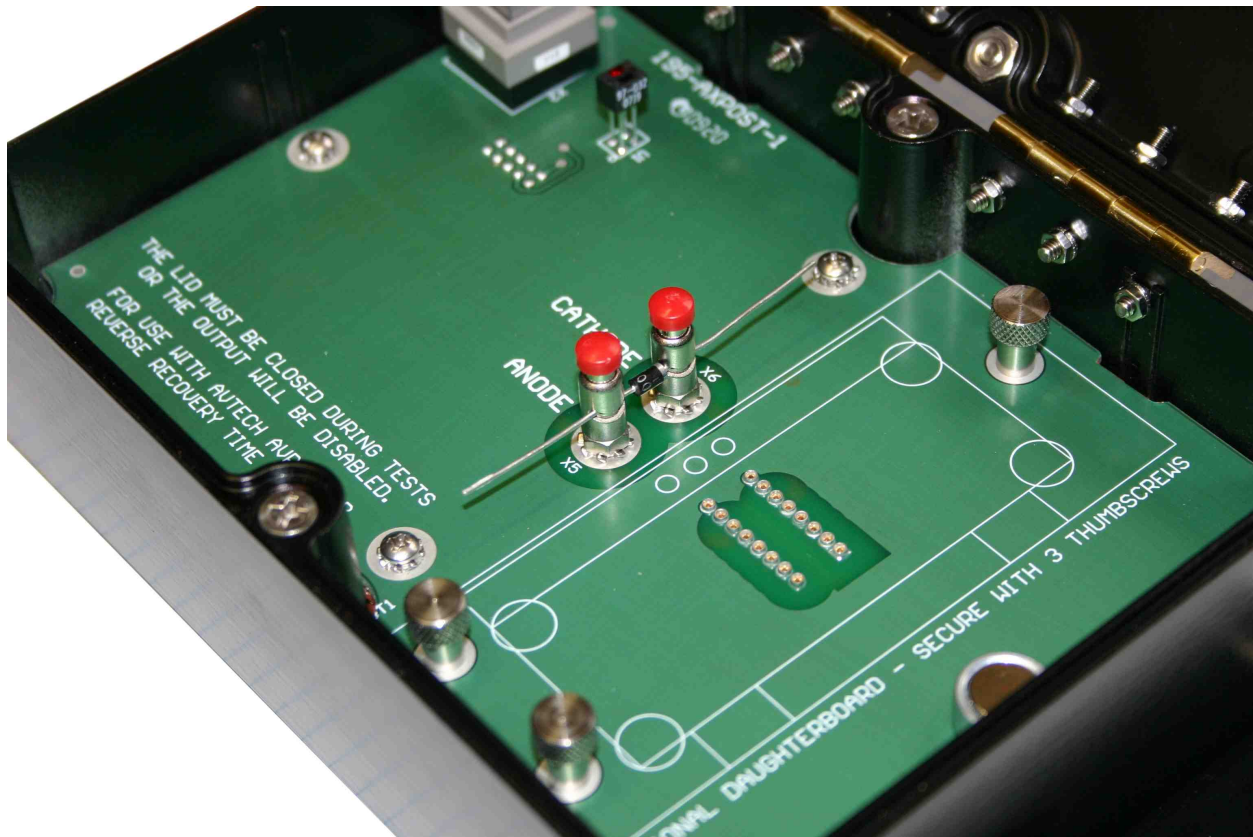

To insert a DUT, push down on the two red post caps with two left-hand fingers while using tweezers in the right hand to insert the DUT into the slots in the posts.

The jig will also accept daughterboards with different mechanisms in the area to the right of the posts, to provide new capabilities in the future.

## MELF PACKAGES

The AVX-TRR-MELF accepts MELF (Metal Electrode Leadless Face) type SMT packages. (Certain customized variants, including the AVX-TRR-SCHA and AVX-TRR-MSB-MELF test jigs, accept the MELF package as well.)

These test jigs use spring-loaded probe pins to contact the device under test. The connection arrangement is the same as for the standard test jig.

The test jig is shown below:



The device under test may be inserted between to spring-loaded pins. These pins are shown below:



Anode spring pin

Cathode spring pin

The next photo shows a MELF device installed between the two pins:



A MELF-packaged  
Device Under Test (DUT)

### CHIP-LEVEL TESTS

Certain test jigs, including the AVX-TRR-MELF, accept chip-level packages.

These test jigs use spring-loaded flat-headed probe pins to contact the device under test. The connection arrangement is the same as for the standard test jig. An example of this arrangement is shown below:

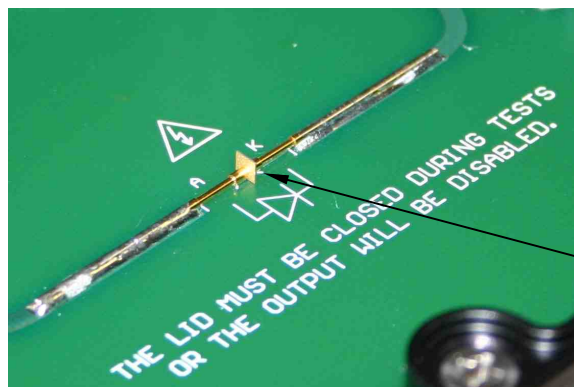

A chip DUT  
sandwiched between  
the two flat-headed  
spring pins.

## DO-4 AND DO-5 STUD PACKAGES

Certain test jigs, such as the AVX-TRR-STUD, accept DO-4 AND DO-5 standard and reverse-polarity stud packages. This test jig is shown below:

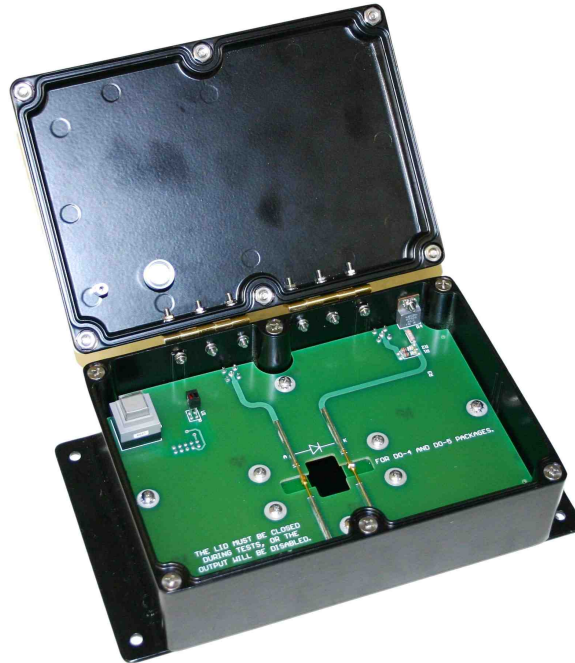

The photo below shows a reverse-polarity DO-4 diode (the Ruttonsha 12FLR60/F05) installed between the four spring-loaded contacts (two for the anode end, and two for the cathode end):

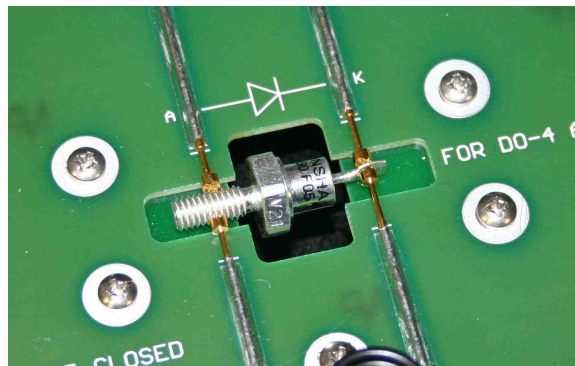

To install the diode, spread apart one pair of spring pins with your fingers or tweezers, and insert one end of the diode. Repeat on the other end.

This diode produced the following results ( $t_{RR} = 341.9 \text{ ns}$ ):

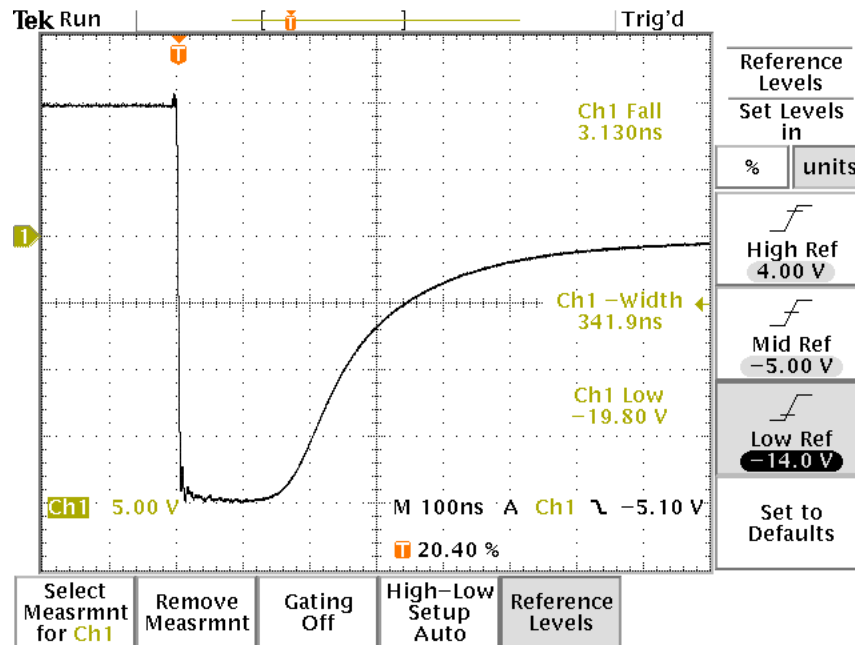

5 V/div (= 1 A/div), 200 ns/div.  
 20%-80% switching time shown.  
 S/N 11713. 60 cm cable used.

The photo below shows a reverse-polarity DO-5 diode (the Ruttonsha 40HF80) installed between the four spring-loaded contacts (two for the anode end, and two for the cathode end):

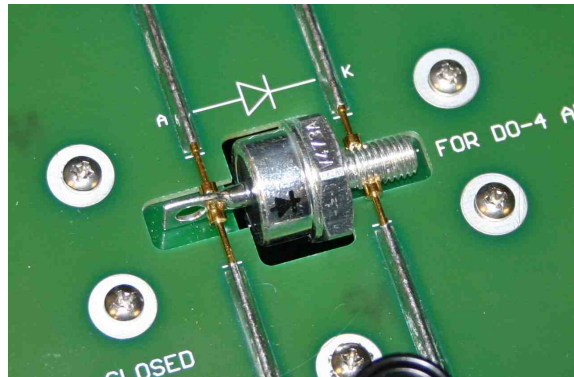

This diode produced the following results ( $t_{RR} = 2.595 \mu\text{s}$ ):

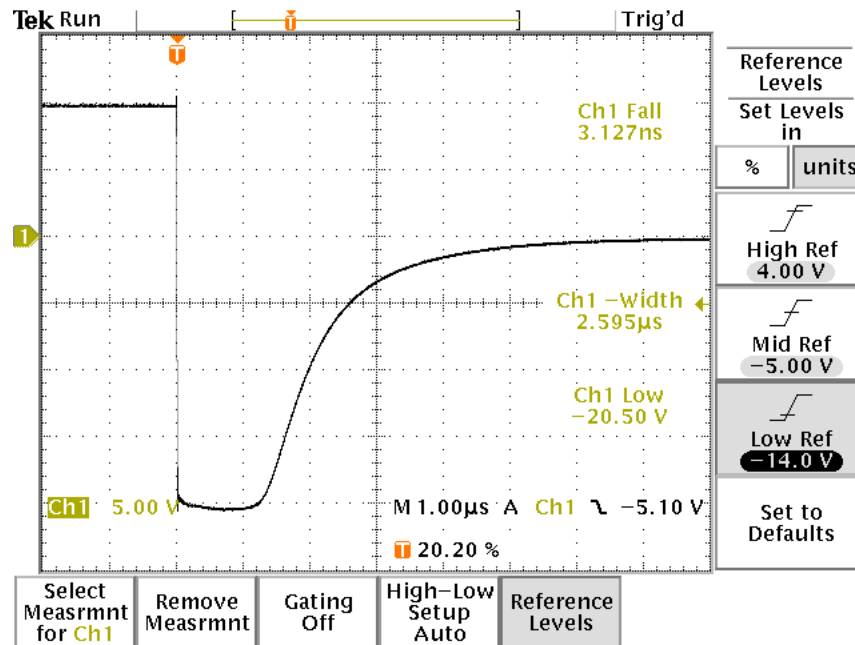

5 V/div (= 1 A/div), 200 ns/div.  
 20%-80% switching time shown.  
 S/N 11713. 60 cm cable used.

### AVX-TRR-BTA TEST JIG

The AVX-TRR-BTA test jig is designed to accept the unusual package shown below:



The AVX-TRR-BTA test jig is shown below:





The DUT is installed by pulling back on the chrome knob, as shown below:



The DUT is then placed on its side in the area immediately in front of the two fixed probe points, as shown in the photo above. Then slowly release the chrome knob,

allowing the spring-loaded PCB to push the DUT into position against the two probe points, as shown below. The PCB silk-screening shows the proper device positioning.

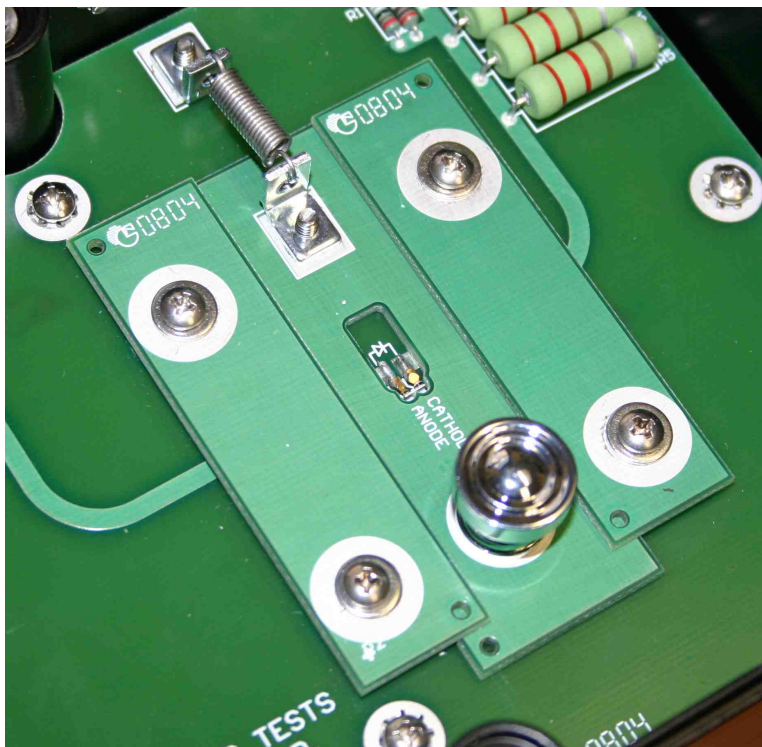

The anode pad must contact the left probe point, and the cathode pin must contact the right probe point.

With a user-supplied device (part number unknown) installed in the AVX-TRR-BTA, and with the amplitudes set to generate  $I_F = +2A$  and  $I_R = -4A$ , the following results were obtained:

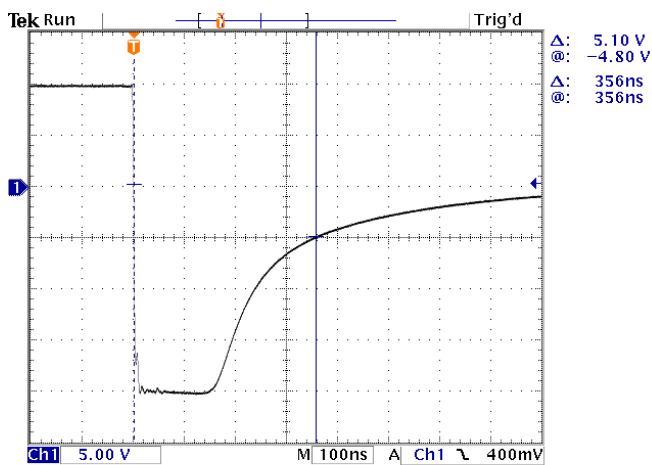

5 V/div (= 1 A/div), 100 ns/div.  
 $t_{RR}$  (at 25% of  $I_R$ ) = 356 ns.  
 S/N 11910. 60 cm cable used.



## TROUBLESHOOTING

If you obtain “strange” output waveforms, or unexpected values of  $t_{RR}$ , keep these points in mind:

- 1) The test jig output *must* be terminated with 50 Ohms.
- 2) The coaxial cable connecting the test jig to the output module should normally be as short as possible (60 cm or less).
- 3) If the measured  $t_{RR}$  seems too long, try reducing the length of the coaxial cable connecting the test jig to the output module as much as possible. (This may or may not affect the measured value, depending on the exact diode switching characteristics.)
- 4) If reflections are observed on the output waveform, increase the length of the coaxial cable connecting the test jig to the output module so that the reflections do not overlap with the reverse transient. This will probably not change the measured value, but it will keep the two effects isolated (the reverse transient and the reflections), for greater measurement confidence.
- 5) Keep device lead lengths as short as possible, to minimize parasitic inductance.
- 6) The test jig lid must be closed, or the pulser output will be disabled.

For technical support, contact [info@avtechpulse.com](mailto:info@avtechpulse.com). Sample waveforms and digital photos of your setup are always helpful!

## PROGRAMMING YOUR PULSE GENERATOR

### KEY PROGRAMMING COMMANDS

The “Programming Manual for -B Instruments” describes in detail how to connect the pulse generator to your computer, and the programming commands themselves. A large number of commands are available; however, normally you will only need a few of these. Here is a basic sample sequence of commands that might be sent to the instrument after power-up:

*rst	(resets the instrument)
trigger:source internal	(selects internal triggering)
frequency 1000 Hz	(sets the frequency to 1000 Hz)
pulse:delay 1 us	(sets the delay to 1 us)
pulse:width1 10 us	(sets the positive pulse width to 10 us)
pulse:width2 5 us	(sets the negative pulse width to 5 us)
volt:ampl1 +100	(sets the positive pulse amplitude to +100 V)
volt:ampl2 -200	(sets the negative pulse amplitude to -200 V)
output on	(turns on the output)

For triggering a single event, this sequence would be more appropriate:

*rst	(resets the instrument)
trigger:source hold	(turns off all triggering)
output on	(turns on the output)
pulse:delay 1 us	(sets the delay to 1 us)
pulse:width1 10 us	(sets the positive pulse width to 10 us)
pulse:width2 5 us	(sets the negative pulse width to 5 us)
volt:ampl1 +100	(sets the positive pulse amplitude to +100 V)
volt:ampl2 -200	(sets the negative pulse amplitude to -200 V)
trigger:source immediate	(generates a single non-repetitive trigger event)
trigger:source hold	(turns off all triggering)
output off	(turns off the output)

To set the instrument to trigger from an external TTL signal applied to the rear-panel TRlg connector, use:

*rst	(resets the instrument)
trigger:source external	(selects external triggering)
pulse:delay 1 us	(sets the delay to 1 us)
pulse:width1 10 us	(sets the positive pulse width to 10 us)
pulse:width2 5 us	(sets the negative pulse width to 5 us)
volt:ampl1 +100	(sets the positive pulse amplitude to +100 V)
volt:ampl2 -200	(sets the negative pulse amplitude to -200 V)
output on	(turns on the output)

These commands will satisfy 90% of your programming needs.

## ALL PROGRAMMING COMMANDS

For more advanced programmers, a complete list of the available commands is given below. These commands are described in detail in the “Programming Manual for -B Instruments”. (Note: this manual also includes some commands that are not implemented in this instrument. They can be ignored.)

<u>Keyword</u>	<u>Parameter</u>	<u>Notes</u>
LOCAL		
OUTPut:		
:[STATE]	<boolean value>	
:PROTection		
:TRIPped?		[query only]
REMOTE		
[SOURce]:		
:FREQuency		
[:CW   FIXed]	<numeric value>	
[SOURce]:		
:PULSe		
:PERiod	<numeric value>	
:WIDTh	<numeric value>	
:DELay	<numeric value>	
:GATE		
:LEVel	High   Low	
[SOURce]:		
:VOLTage		
[:LEVel]		
[:IMMediate]		
[:AMPLitude]	<numeric value>	
:PROTection		
:TRIPped?		[query only]
STATUS:		
:OPERation		
:[EVENT]?		[query only, always returns "0"]
:CONDition?		[query only, always returns "0"]
:ENABle	<numeric value>	[implemented but not useful]
:QUEStionable		
:[EVENT]?		[query only, always returns "0"]
:CONDition?		[query only, always returns "0"]
:ENABle	<numeric value>	[implemented but not useful]
SYSTEM:		
:COMMunicate		
:GPIB		
:ADDResS	<numeric value>	
:SERial		
:CONTRol		
:RTS	ON   IBFull   RFR	
:[RECeive]		
:BAUD	1200   2400   4800   9600	

:BITS	7   8	
:ECHO	<boolean value>	
:PARity		
:[TYPE]	EVEN   ODD   NONE	
:SBITS	1   2	
:ERRor		
:[NEXT]?		[query only]
:COUNT?		[query only]
:VERSion?		[query only]
TRIGger:		
:SOURce	INTernal   EXTernal   MANual   HOLD   IMMEDIATE	
*CLS		[no query form]
*ESE	<numeric value>	
*ESR?		[query only]
*IDN?		[query only]
*OPC		
*SAV	0   1   2   3	[no query form]
*RCL	0   1   2   3	[no query form]
*RST		[no query form]
*SRE	<numeric value>	
*STB?		[query only]
*TST?		[query only]
*WAI		[no query form]

## MECHANICAL INFORMATION

### TOP COVER REMOVAL

If necessary, the interior of the instrument may be accessed by removing the four Phillips screws on the top panel. With the four screws removed, the top cover may be slid back (and off).

 Always disconnect the power cord and allow the instrument to sit unpowered for 10 minutes before opening the instrument. This will allow any internal stored charge to discharge.

There are no user-adjustable internal circuits. For repairs other than fuse replacement, please contact Avtech (info@avtechpulse.com) to arrange for the instrument to be returned to the factory for repair. Service is to be performed solely by qualified service personnel.

 Caution: High voltages are present inside the instrument during normal operation. Do not operate the instrument with the cover removed.

### RACK MOUNTING

A rack mounting kit is available. The -R5 rack mount kit may be installed after first removing the one Phillips screw on the side panel adjacent to the front handle.

### ELECTROMAGNETIC INTERFERENCE

To prevent electromagnetic interference with other equipment, all used outputs should be connected to shielded loads using shielded coaxial cables. Unused outputs should be terminated with shielded coaxial terminators or with shielded coaxial dust caps, to prevent unintentional electromagnetic radiation. All cords and cables should be less than 3m in length.

## MAINTENANCE

### REGULAR MAINTENANCE

This instrument does not require any regular maintenance.

On occasion, one or more of the four rear-panel fuses may require replacement. All fuses can be accessed from the rear panel. See the “FUSES” section for details.

### CLEANING

If desired, the interior of the instrument may be cleaned using compressed air to dislodge any accumulated dust. (See the “TOP COVER REMOVAL” section for instructions on accessing the interior.) No other cleaning is recommended.

# WIRING DIAGRAMS

## WIRING OF AC POWER

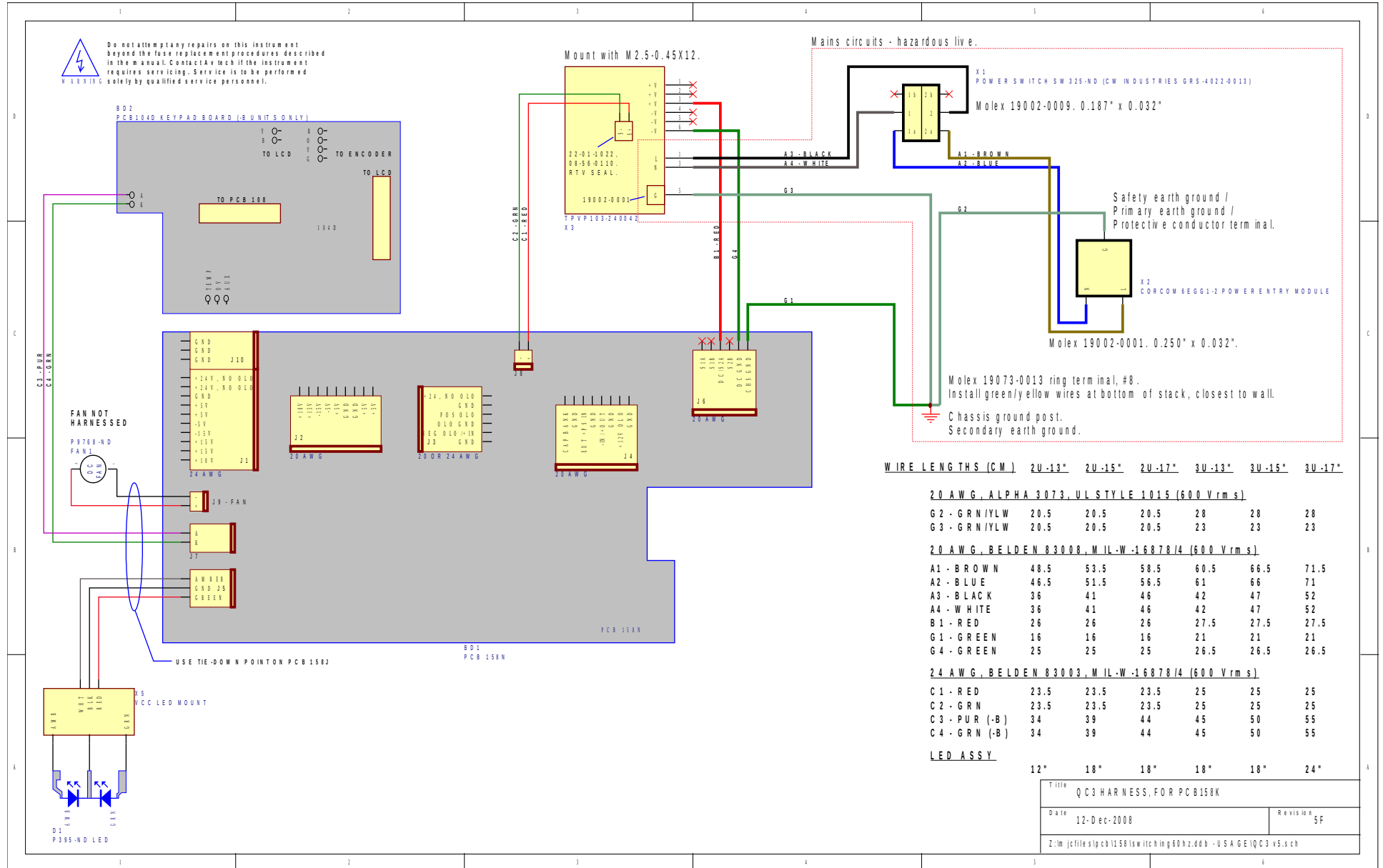

# PCB 158N - LOW VOLTAGE POWER SUPPLY, 1/3

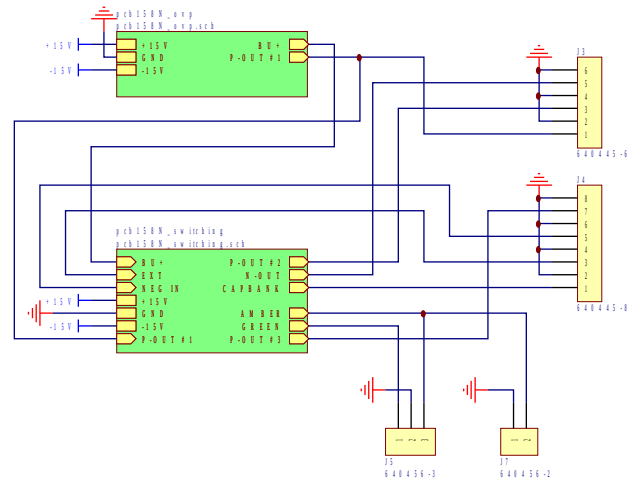

Title		LOW VOLTAGE DC/DC POWER SUPPLY
Date	12-Dec-2008	Revision
Z:\m\jcf\files\pcb\158\switching\60hz\dd0-158N\pcb158N.sch		





# PCB 158N - LOW VOLTAGE POWER SUPPLY, 3/3

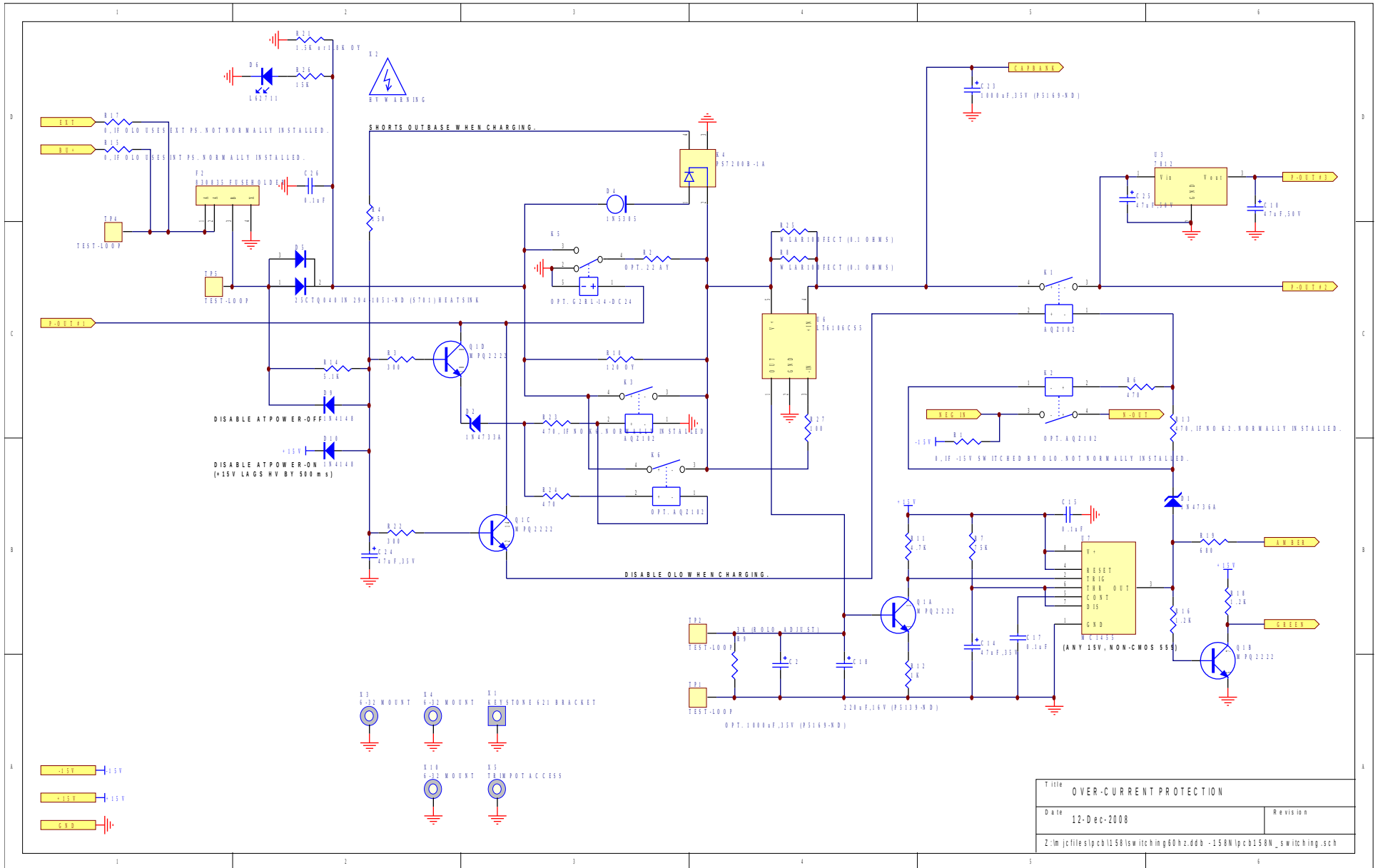

# PCB 168B - HIGH VOLTAGE DC POWER SUPPLY

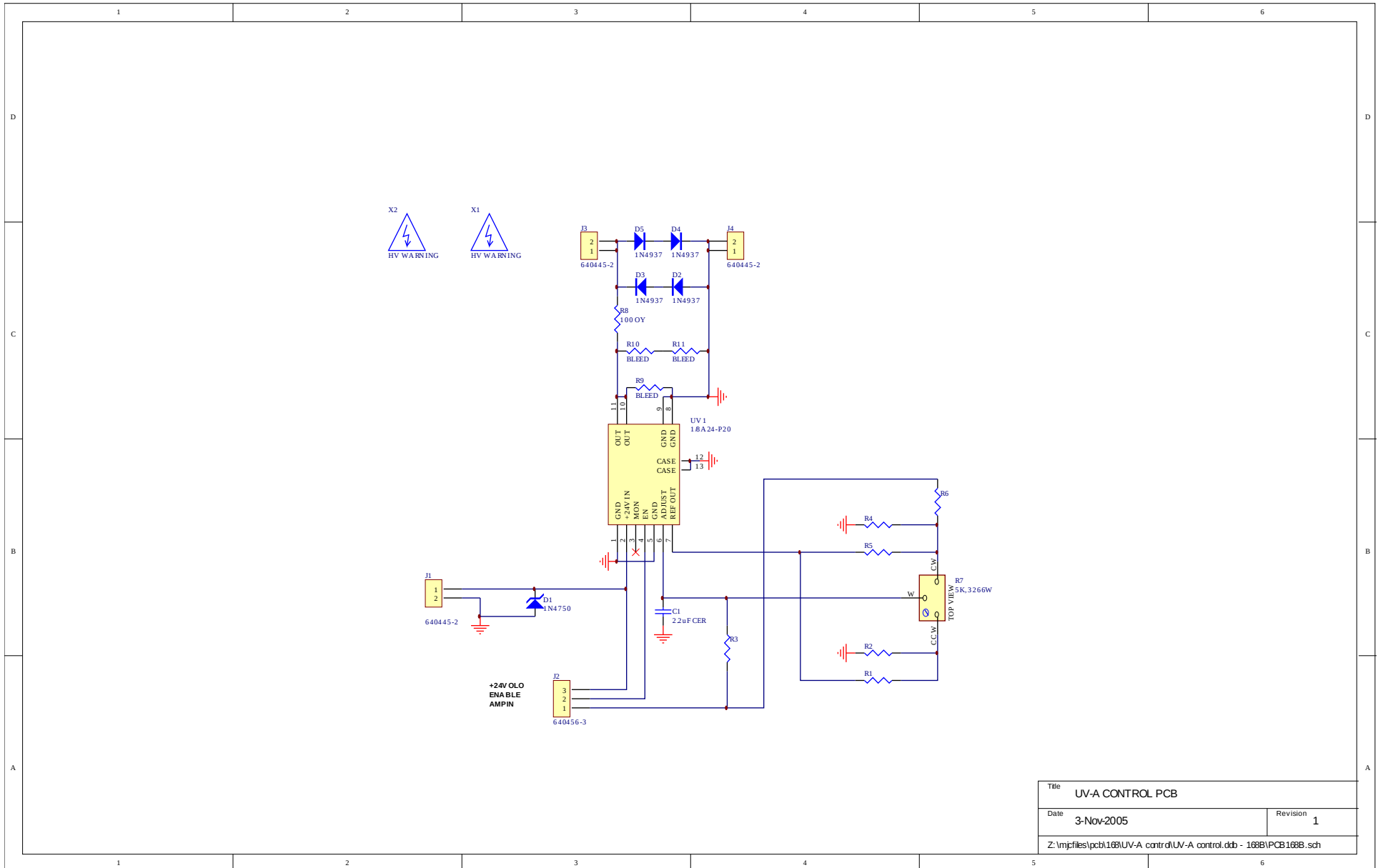

Title UV-A CONTROL PCB	
Date 3-Nov-2005	Revision 1
Z:\m\jfiles\pcb168\UV-A control\UV-A control.ddb - 168B\PCB168B.sch	

# PCB 104D - KEYPAD / DISPLAY BOARD, 1/3

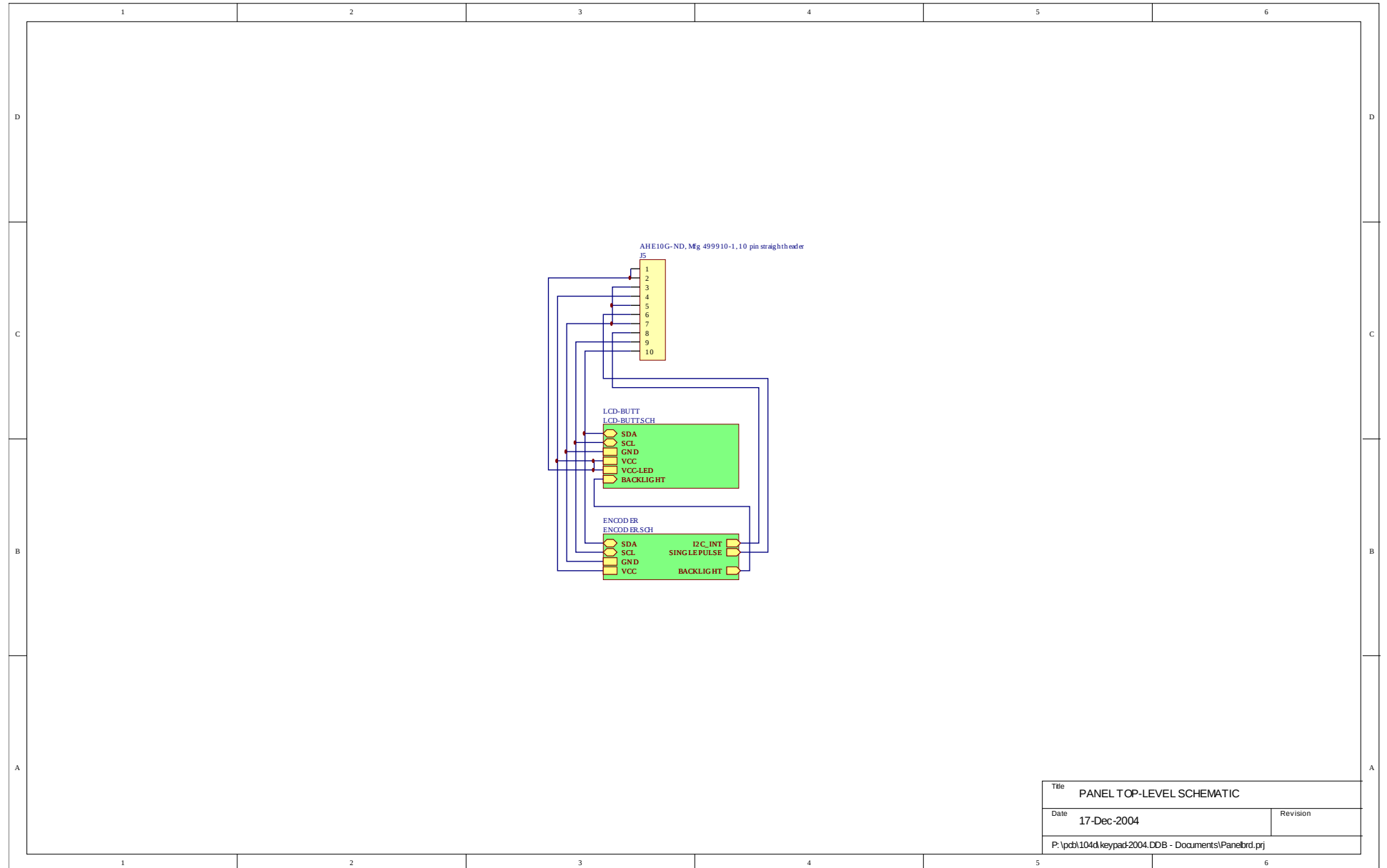

Title		PANEL TOP-LEVEL SCHEMATIC	
Date	17-Dec-2004	Revision	
P:\pcb\104d\keypad\2004.DDB - Documents\Panelbrd.prj			

# PCB 104D - KEYPAD / DISPLAY BOARD, 2/3

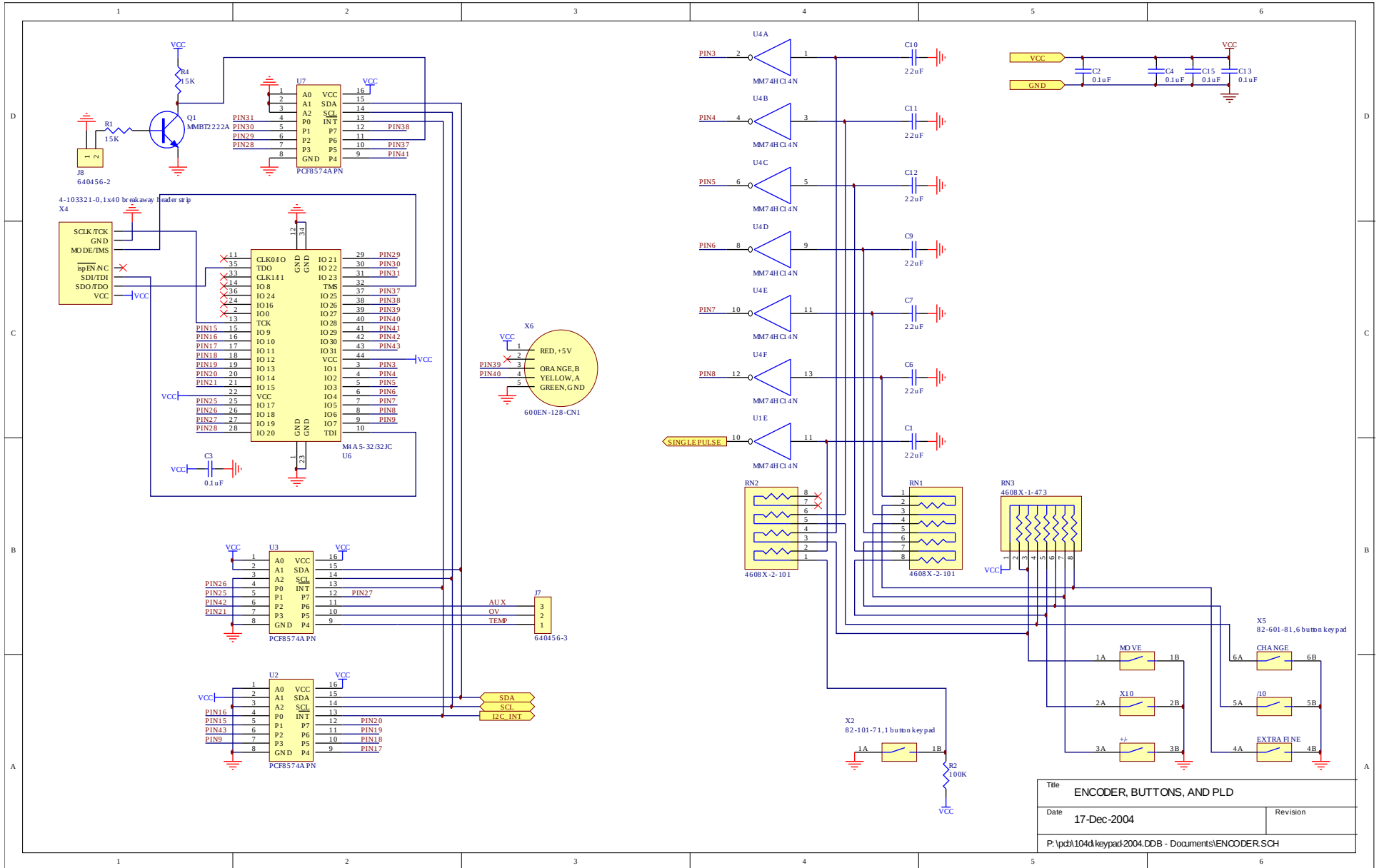

# PCB 104D - KEYPAD / DISPLAY BOARD, 3/3

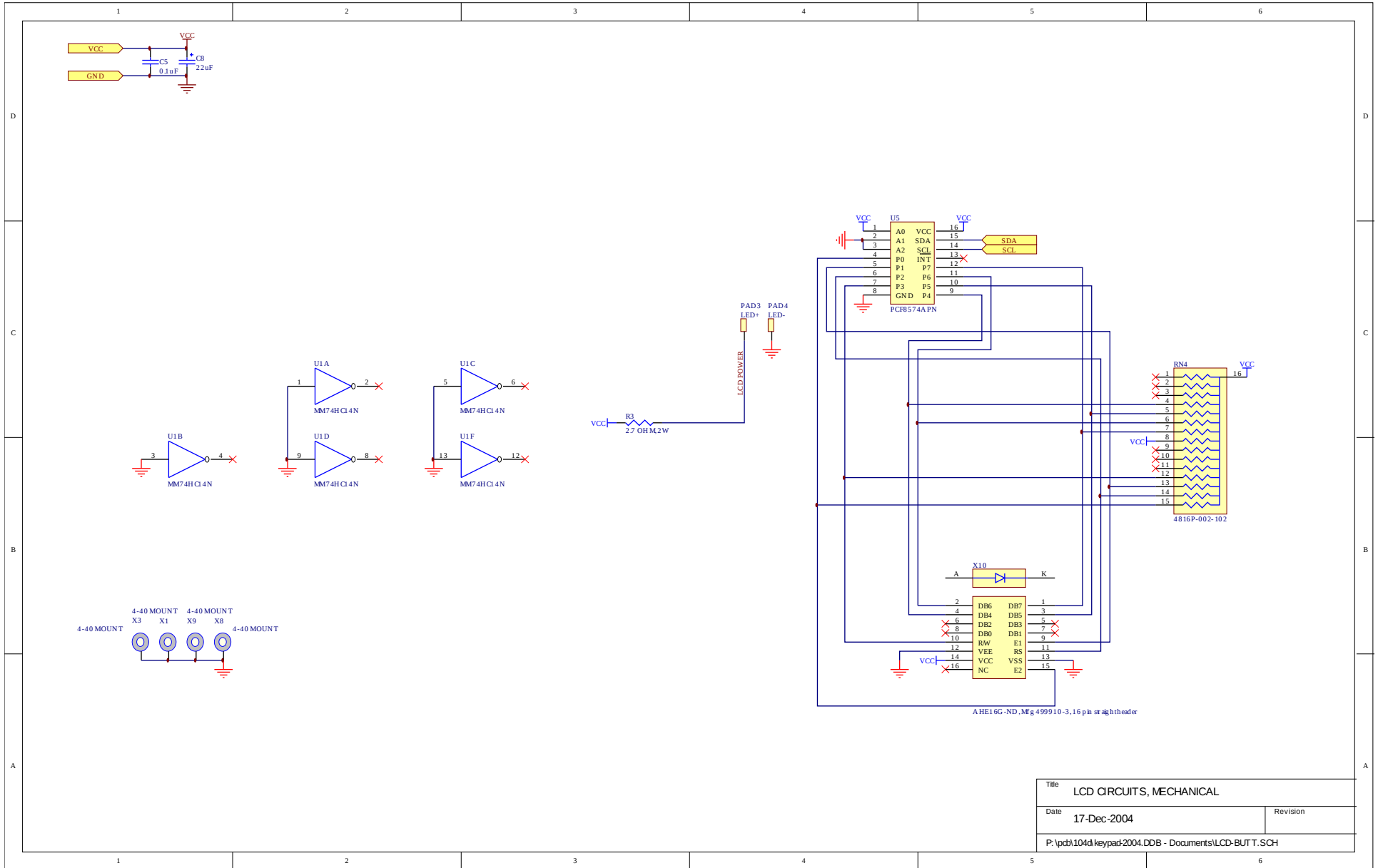

# MAIN WIRING

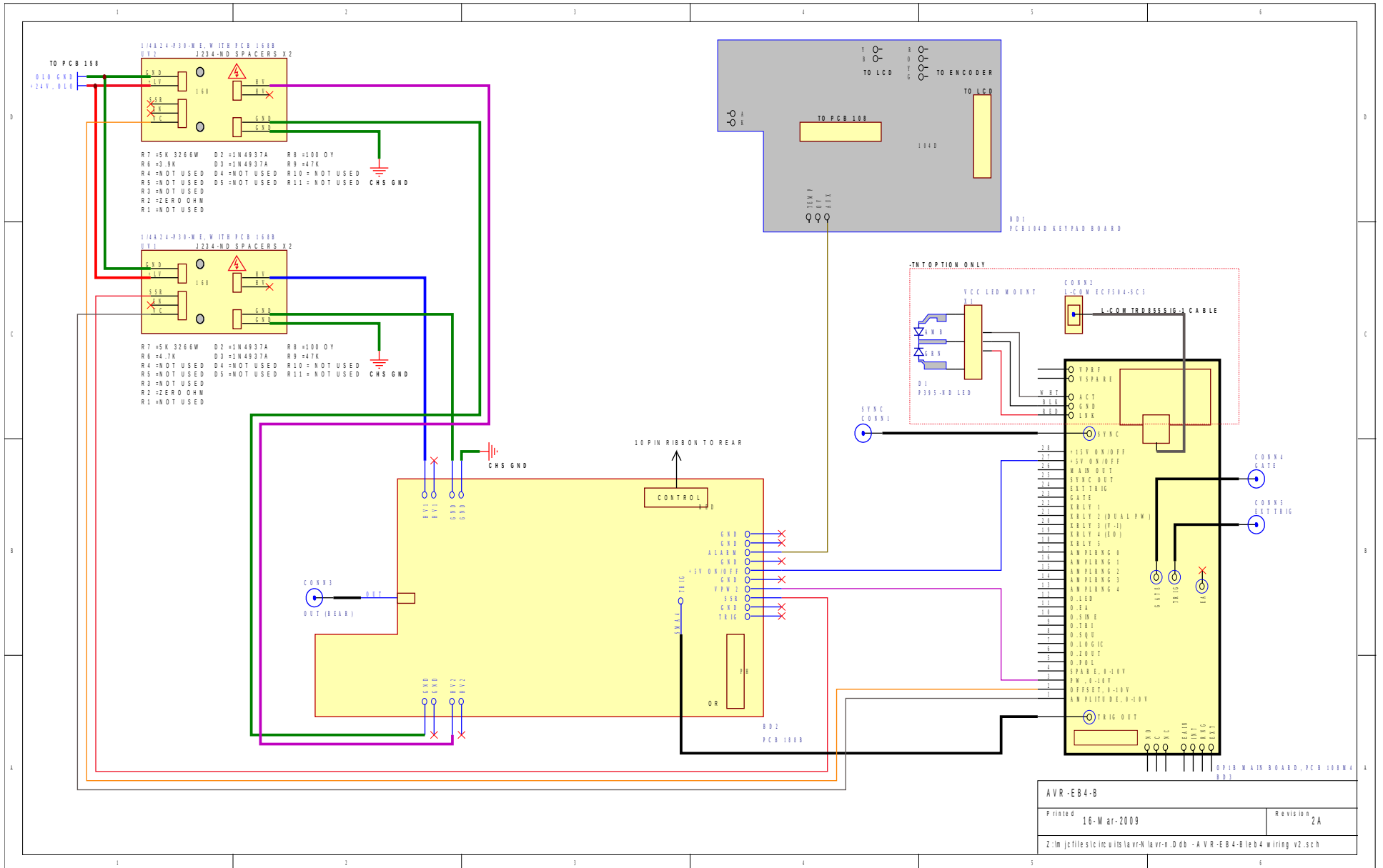

# STANDARD TEST JIG WIRING (AVX-TRR-MIX)

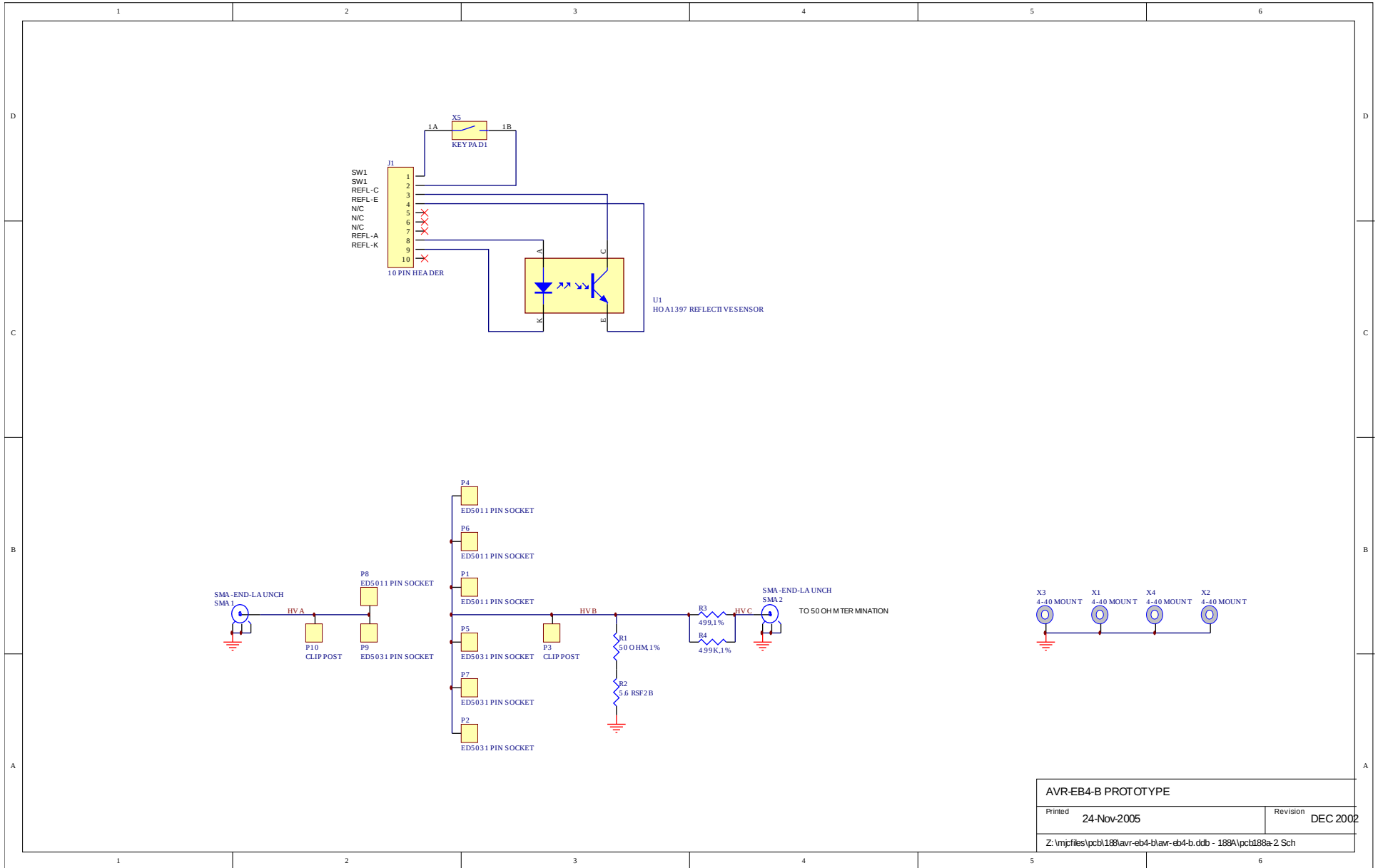

AVR-EB4-B PROTOTYPE	
Printed 24-Nov-2005	Revision DEC 2002
Z:\mjrfiles\pct1188\avr-eb4-blav-eb4-b.ddb - 188A\pct1188a-2 Sch	





TEST JIG WIRING (AVX-TRR-SCHA / AVX-TRR-MSB-MELF)

# TEST JIG WIRING (AVX-TRR-SCHA / AVX-TRR-MSB-STUD)

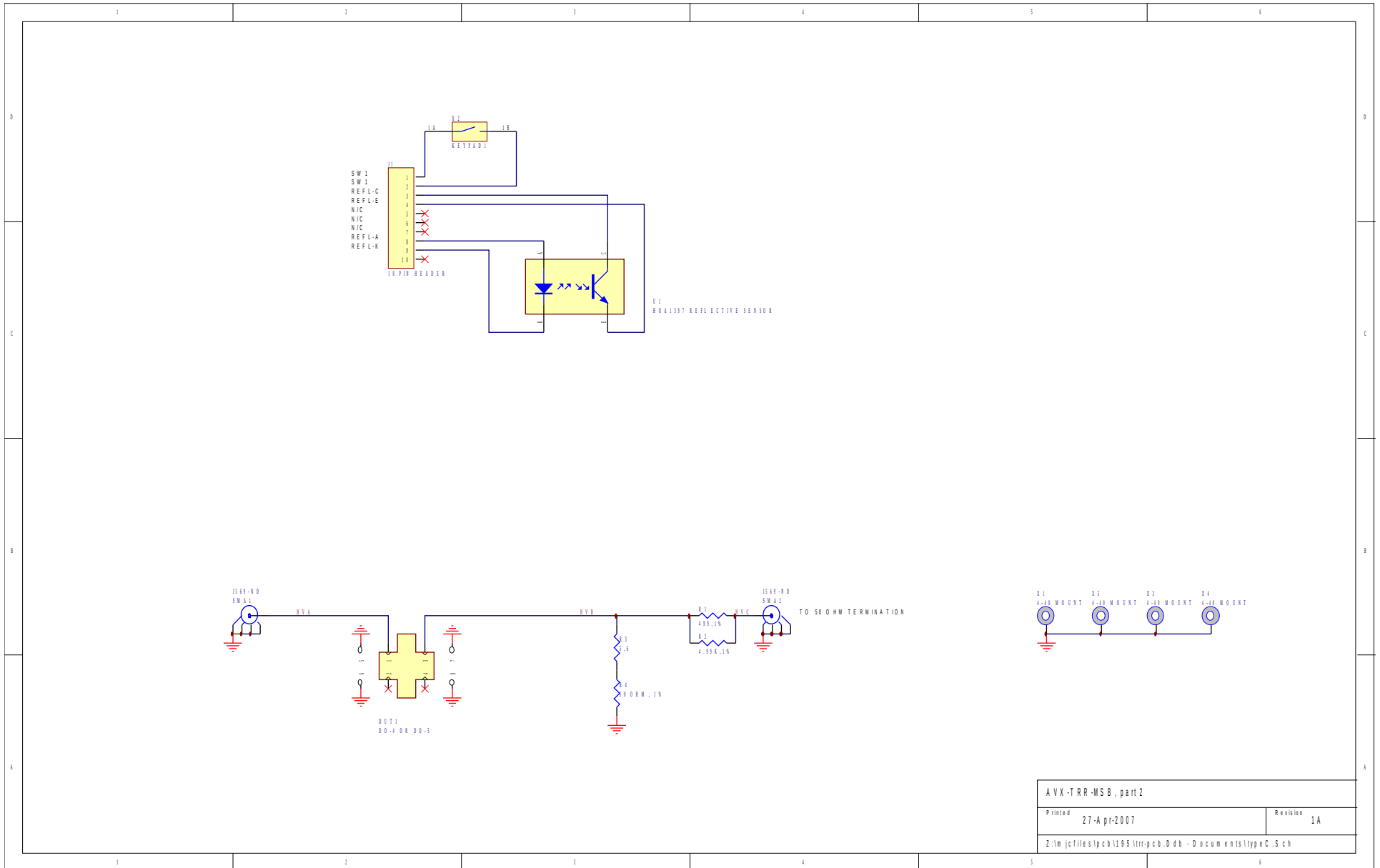

# TEST JIG WIRING (AVX-TRR-BTA)

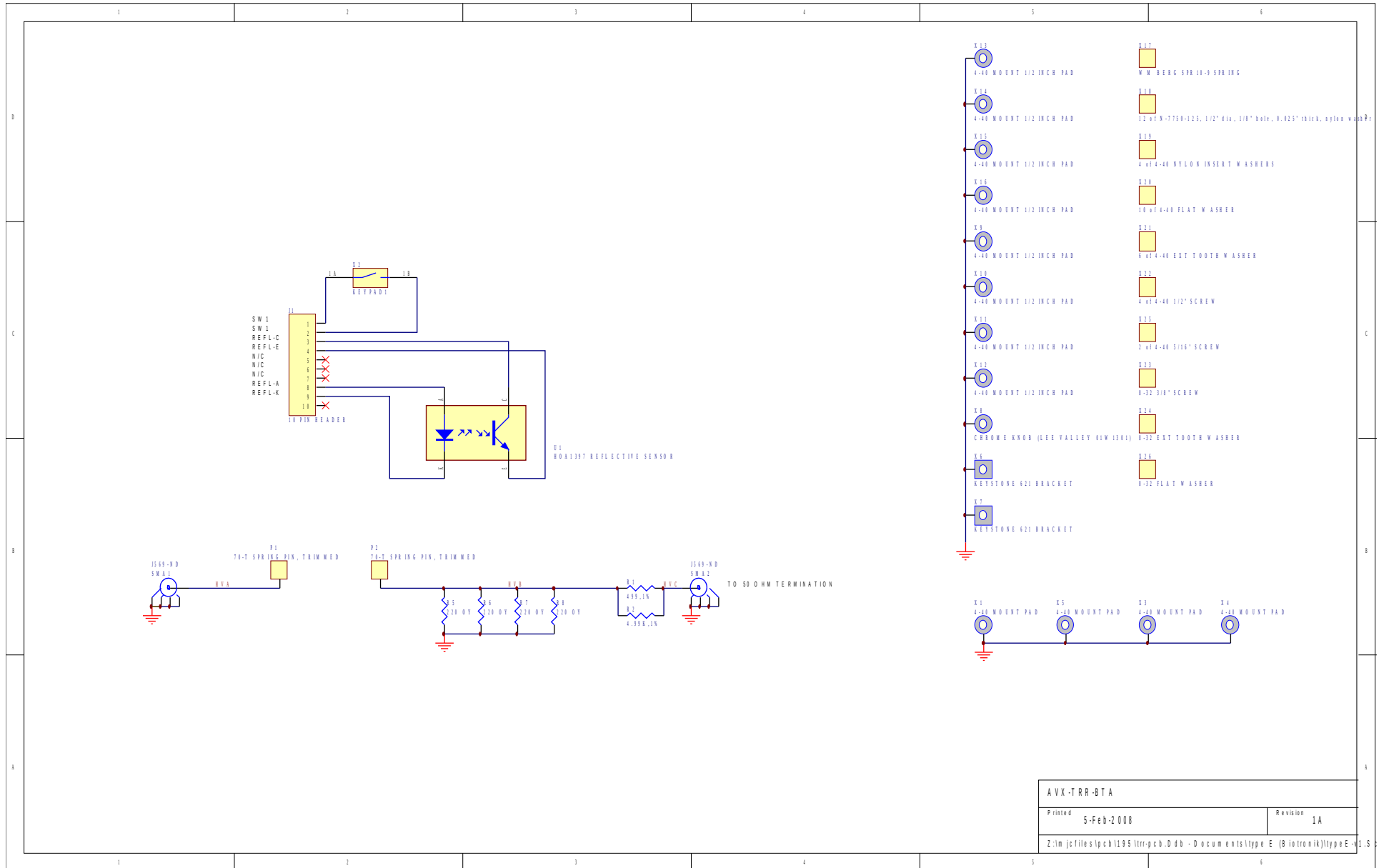

PERFORMANCE CHECK SHEET